



Serie axiale wandventilatoren voorzien van plastic waaiers. Uitgevoerd met een eenfasige motor (HCFB) of driefasige motor (HCFT), IP65 (1), klasse F isolatie (2), uitgerust met thermische beveiliging (3).

(1) Ø 800, 900 en 1000 modellen zijn IP55.

(2) Bedrijfstemperaturen van -40 °C tot 70 °C. Behalve modellen 4-710 geschikt voor gebruik in omgevingen tot +55°C en Ø 800 tot 1000 geschikt voor gebruik in omgevingen van -20 °C tot 40 °C.

(3) Behalve modellen 800 tot 1000.

Motoren

Afhankelijk van het beschikbare model met een- of driefasige motoren met 2, 4 of 6 polen. Bij alle motoren kan de snelheid worden gereguleerd door een transformator, behalve bij 2-polige en /4-630, 710, T/800, T/900 en T/1000. Bij driefasige modellen kan de snelheid worden geregeld door een frequentieregelaar.

Elektrische voeding:

- Eenfasige 230 V-50 Hz.
[Condensator zit in aansluitdoos voor bedrading].
- Driefasige 230/400 V-50 Hz of 400 V-50 Hz.
[Zie kaart met gegevens].

Op aanvraag:

Beschermend aanzuigrooster voor modellen Ø 800 tot 1000.

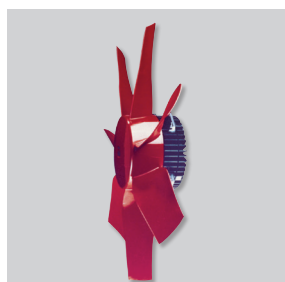

Compact design. Motor waaier combinatie

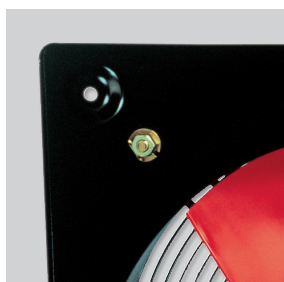

Corrosiebestendigheid! Montageplaat, motorsteun en beschermrooster, beschermd door kataforese grondlaag. Afwerking met zwarte polyester verflaag. Roestrijf stalen schroeven.

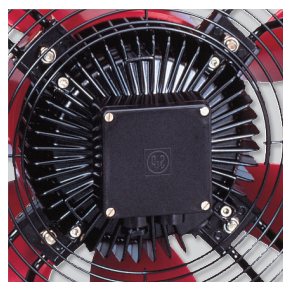

Brandwerende aansluitdoos Aansluitdoos met wartel PG-11.



BESCHERMING

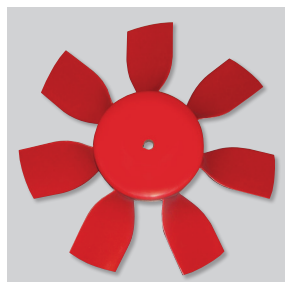

Waaier dynamisch uitgebalanceerd conform de ISO 1940 norm, waardoor deze trillingsvrij werken



Groter diversiteit in waaiers. Afhangelijk van de toepassing.



Configuratie voor modellen Ø 800 tot 1000

Speciaal design van motor boven waaier, wat zorgt voor compactheid (IP55).



BESCHERMING

Specifieke toepassingen



Versies

Serie axiale wandventilatoren voorzien van aluminium waaiers en eenfasige motor (HCBB) of driefasige motor (HCBT), IP65 (1), klasse F isolatie (2), uitgerust met thermische beveiliging (3).

- (1) Ø 800, 900 en 1000 modellen zijn IP55.
 (2) Bedrijfstemperaturen van -40 °C tot 70 °C.
 Behalve de modellen 4-710 geschikt voor gebruik in omgevingen tot +55°C en Ø 800, 900 en 1000 geschikt voor gebruik in omgevingen van -20 °C tot +40 °C.
 (3) Behalve modellen 800 tot 1000.

Motoren

Afhankelijk van het model beschikbaar met een- of driefasige motoren met 4 of 6 polen. Bij alle motoren kan de snelheid worden gereguleerd door een transformator, behalve bij /4-630, B/710, T/4-710, T/800, T/900 en T/1000. Bij driefasige modellen kan de snelheid worden geregeld door een frequentieregelaar.

Elektrische voeding:
 Eenfasige 230 V-50 Hz.
 [Condensator zit in aansluitdoos voor bedrading].
 Driefasige 230/400 V-50 Hz of 400 V-50 Hz.
 [Zie kaart met gegevens].

Aanvullende informatie

Standaard richting lucht: formulier (A) configuratie. (Motor boven waaier).

Op aanvraag

Beschermend aanzuigrooster voor modellen Ø 800 tot 1000.

HCBT ATEX Versies

Op verzoek, explosieveilige versies conform ATEX norm, 3 fase modellen:

- Motoren IP55, Klasse F.
- ATEX vlamproef-gas
- De standaardversie van de vuurvaste ATEX motor is niet voorzien van thermische beveiligingen.

In geval van gebruik met een frequentieomvormer moet een vuurvaste motor met een thermische beveiliging van het PTC-type worden besteld

Voor de modellen 800 tot 1000

- ⊗ II 2G Ex d IIB T4
- ⊗ II 2G Ex d IIB H2+T4 (met Ex d IIC T4)

- ATEX verhoogde veiligheid- gas
- Behalve de modellen HCBT/ 4-250, HCBT/ 6-355, HCBT/ 6-400

Verkrijgbaar model HCBT/ 6-400 met

230/400 V motor

Verkrijgbaar modellen tot to HCBT-1000

- ⊗ II 2G Ex e II T3

- ATEX - Dust

De standaardversie van de ATEX motor voor stof is niet voorzien van thermische beveiligingen.

In geval van gebruik met een frequentieomvormer moet een ATEX motor voor stof met een thermische beveiliging van het PTC-type worden besteld

Voor de modellen 800 tot 1000

Brandbare stofdeeltjes en geleidende stof:

- ⊗ II 3D Ex tc IIIB T125°C

Geleidende stof:

- ⊗ II 3D Ex tc IIIC T125°C (met IP65 motor)

Bedrijfstemperaturen van ATEX versies:

Van -20 °C tot +55 °C:

- modellen HCBT/4-315 tot HCBT/4-710
- modellen HCBT/6-450 tot HCBT 6-710

- Van -20 °C tot +40 °C:

- model HCBT/4-800 tot 1000
- model HCBT/6-800 tot 1000

Voor selectie van HCBT ATEX raadpleeg Easyvent. Opm. De elektrische gegevens kunnen afwijken bij ATEX motoren.



Compact design Motor waaier combinatie

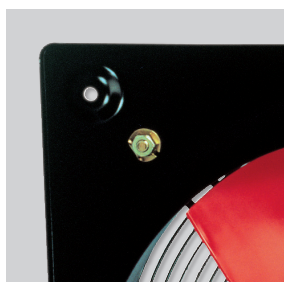

Corrosiebestendigheid
 Montageplaat, motorsteun en beschermrooster, beschermd door kataforese grondlaag
 Afwerking met zwarte polyester verflaag. Roestvrij stalen schroeven.

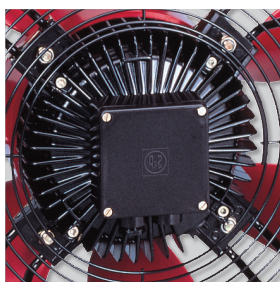

Brandwerende aansluitdoos
 Aansluitdoos met wartel PG-11.

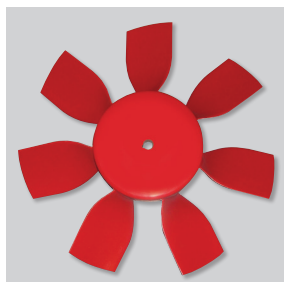

Waaier dynamisch uitgebalanceerd
 Waaiers zijn dynamisch uitgebalanceerd, conform de ISO 1940 norm, waardoor deze trillingsvrij werken.



Groter diversiteit in waaiers. Afhankelijk van de toepassing.



Configuratie voor modellen Ø 800 tot 1000
 Speciaal design van motor boven waaier, wat zorgt voor compactheid (IP55).

TECHNISCHE GEGEVENS MET KUNSTSTOF WAAIERS (HCGB, HCFB, HCGT & HCFT) MET ALUMINIUM WAAIERS

Controleer vóór het tot stand brengen van een elektrische aansluiting of de spanning en de frequentie van het lichtnet overeenkomen met de technische gegevens op het typeplaatje.

Model	Toerental (r.p.m.)	Diameter (mm)	Maximaal opgenomen vermogen (W)	Maximale stroom (A)		Geluids- druk (dB(A))	Maximale capaciteit (m³/h)	Gewicht (Kg)	Snelheidsregelaar		Frequentieregelaar
				bij 230 V	bij 400 V				REB	SPTM**	
ENKELFASIG 4 POLEN											
HCBB/4-250/H	1325	250	84	0,4	–	49	1.130	5	REB-1	SPTM 2-1,5	–
HCBB/4-315/H	1235	315	124	0,7	–	55	2.220	7	REB-1	SPTM 2-1,5	–
HCBB/4-355/H	1385	355	193	0,9	–	59	3.590	8	REB-2,5	SPTM 2-1,5	–
HCBB/4-400/H	1360	400	315	1,5	–	62	4.830	9	REB-2,5	SPTM 2-3	–
HCBB/4-450/H	1410	450	626	2,8	–	65	7.180	13	REB-5	SPTM 2-3	–
HCBB/4-500/H	1370	500	762	3,3	–	68	8.850	16	REB-5	SPTM 2-3	–
HCBB/4-560/H	1390	560	1433	6,5	–	70	13.400	22	REB-10	SPTM 2-7	–
HCBB/4-630/H	1360	630	1879	8,3	–	71	16.720	25	–	–	–
ENKELFASIG 6 POLEN											
HCBB/6-355/H	900	355	84	0,4	–	48	2.230	8	REB-1	SPTM 2-1,5	–
HCBB/6-400/H	845	400	112	0,5	–	51	3.010	9	REB-1	SPTM 2-1,5	–
HCBB/6-450/H	935	450	191	0,8	–	54	4.400	13	REB-2,5	SPTM 2-1,5	–
HCBB/6-500/H	915	500	244	1,1	–	57	5.620	16	REB-2,5	SPTM 2-1,5	–
HCBB/6-560/H	930	560	449	1,9	–	59	8.950	22	REB-2,5	SPTM 2-1,5	–
HCBB/6-630/H	915	630	588	2,9	–	62	10.950	25	REB-5	SPTM 2-3	–
DRIEFASIG 4 POLEN											
HCBT/4-250/H	1330	250	81	0,3	0,2	49	1.120	5	–	SPTM 3-2	FI 0,75kW 2,2A
HCBT/4-315/H	1330	315	125	0,5	0,3	55	2.380	7	–	SPTM 3-2	FI 0,75kW 2,2A
HCBT/4-355/H	1380	355	181	0,8	0,5	59	3.530	8	–	SPTM 3-2	FI 0,75kW 2,2A
HCBT/4-400/H	1340	400	283	1,2	0,7	62	5.020	9	–	SPTM 3-2	FI 0,75kW 2,2A
HCBT/4-450/H	1350	450	547	1,7	1,0	65	6.800	13	–	SPTM 3-2	FI 0,75kW 2,2A
HCBT/4-500/H	1390	500	809	2,7	1,6	68	9.140	16	–	SPTM 3-3	FI 0,75kW 2,2A
HCBT/4-560/H	1390	560	1287	4,0	2,3	70	12.950	22	–	SPTM 3-3	FI 1,5kW 4,1A
HCBT/4-630/H	1385	630	1736	5,4	3,1	73	16.840	25	–	–	FI 1,5kW 4,1A
HCBT/4-710/H	1350	710	2554	7,6	4,4	74	22.400	27	–	–	FI 2,2kW 5,8A
HCBT/4-800/L-X-1,5	1410	800	2632	7,3	4,2	78	23.290	37	–	–	FI 2,2kW 5,8A
HCBT/4-800/H-X-3	1440	800	4595	12,8	7,4	84	33.100	52	–	–	FI 4,0kW 9,5A
HCBT/4-900/L-X-3	1450	900	3909	12,0	6,9	82	34.270	61,5	–	–	FI 4,0kW 9,5A
HCBT/4-900/H-X-5,5	1455	900	7893	–	13,4	87	46.270	112	–	–	FI 5,5kW 14A
HCBT/4-1000/L-X-3	1415	1000	5048	14,2	8,2	86	39.910	67	–	–	FI 4,0kW 9,5A
HCBT/4-1000/H-X-5,5	1440	1000	9227	–	15,1	93	49.200	95	–	–	FI 7,5kW 18A
DRIEFASIG 6 POLEN											
HCBT/6-355/H	900	355	91	0,3	0,2	48	2.270	8	–	SPTM 3-2	FI 0,75kW 2,2A
HCBT/6-400/H	840	400	120	0,5	0,3	51	3.050	9	–	SPTM 3-2	FI 0,75kW 2,2A
HCBT/6-450/H	925	450	198	0,9	0,5	54	4.620	13	–	SPTM 3-2	FI 0,75kW 2,2A
HCBT/6-500/H	905	500	282	1,1	0,6	57	6.190	16	–	SPTM 3-2	FI 0,75kW 2,2A
HCBT/6-560/H	895	560	401	1,4	0,8	59	8.650	22	–	SPTM 3-2	FI 0,75kW 2,2A
HCBT/6-630/H	910	630	596	2,3	1,3	62	10.950	25	–	SPTM 3-2	FI 0,75kW 2,2A
HCBT/6-710/H	950	710	953	4,7	2,7	65	15.350	27	–	SPTM 3-3	FI 1,5kW 4,1A
HCBT/6-800/L-X-0,55	940	800	1025	3,3	1,9	73	17.600	31	–	–	FI 0,75kW 2,2A
HCBT/6-800/H-X-0,75	935	800	1309	4,2	2,4	75	20.630	36	–	–	FI 1,5kW 4,1A
HCBT/6-900/L-X-1,1	960	900	1341	4,8	2,8	74	23.700	54	–	–	FI 1,5kW 4,1A
HCBT/6-900/H-X-1,5	955	900	2289	7,3	4,2	78	32.300	95	–	–	FI 2,2kW 5,8A
HCBT/6-1000/L-X-1,1	940	1000	1855	5,9	3,4	79	28.810	56	–	–	FI 1,5kW 4,1A
HCBT/6-1000/H-X-1,5	940	1000	2795	8,5	4,9	84	37.710	62	–	–	FI 2,2kW 5,8A

* Geluiddruk gemeten in vrije veld condities, op een afstand equivalent aan 3 maal de diameter van de waaier, met een minimum van 1,5 meter.

** De driefaseregelaars (SPTM) of frequency regelaar (VFKB / VFTM) worden aanbevolen bij 400 V

TECHNISCHE GEGEVENS MET KUNSTSTOF WAAIERS (HCGB, HCFB, HCGT & HCFT)

Controleer vóór het tot stand brengen van een elektrische aansluiting of de spanning en de frequentie van het lichtnet overeenkomen met de technische gegevens op het typeplaatje.

Model	Toerental (r.p.m.)	Diameter (mm)	Maximaal opgenomen vermogen (W)	Maximale stroom (A)		Geluids-druk (dB(A))	Maximale capaciteit (m³/h)	Gewicht (Kg)	Snelheidsregelaar		Frequentieregelaar
				bij 230 V	bij 400 V				REB	SPTM-2**	
ENKELFASIG 2 POLEN											
HCGB/2-315/I	2690	315	336	1,5	-	63	3.150	7	-	-	-
HCGB/2-355/I	2730	355	392	1,7	-	68	3.550	8	-	-	-
ENKELFASIG 4 POLEN											
HCFB/4-250/H	1380	250	77	0,3	-	49	1.090	5	REB-1	SPTM 2-2	-
HCFB/4-315/H	1340	315	125	0,6	-	55	2.220	7	REB-1	SPTM 2-2	-
HCFB/4-355/H	1415	355	168	0,7	-	59	3.470	8	REB-2,5	SPTM 2-2	-
HCFB/4-400/H	1420	400	271	1,2	-	62	4.920	9	REB-2,5	SPTM 2-3	-
HCFB/4-450/H	1380	450	471	2,0	-	65	6.830	13	REB-2,5	SPTM 2-3	-
HCFB/4-500/H	1400	500	671	2,9	-	68	9.140	16	REB-5	SPTM 2-3	-
HCFB/4-560/H	1410	560	1102	4,7	-	70	12.980	22	REB-5	SPTM 2-7	-
HCFB/4-630/H	1380	630	1573	7,1	-	73	17.230	25	-	-	-
ENKELFASIG 6 POLEN											
HCFB/6-315/H	990	315	80	0,4	-	45	1.620	7	REB-1	SPTM 2-2	-
HCFB/6-355/H	920	355	81	0,4	-	48	2.250	8	REB-1	SPTM 2-2	-
HCFB/6-400/H	885	400	100	0,4	-	51	2.980	9	REB-1	SPTM 2-2	-
HCFB/6-450/H	920	450	103	0,7	-	54	3.510	13	REB-2,5	SPTM 2-2	-
HCFB/6-500/H	920	500	224	1,0	-	57	6.030	16	REB-2,5	SPTM 2-3	-
HCFB/6-560/H	905	560	321	1,3	-	59	8.180	22	REB-2,5	SPTM 2-3	-
HCFB/6-630/H	915	630	469	2,0	-	62	11.000	25	REB-5	SPTM 2-3	-
DRIEFASIG 2 POLEN											
HCGT/2-315/L	2630	315	461	1,4	0,81	68	3.790	7	-	-	FI 0,75kW 2,2A
HCGT/2-355/I	2570	355	497	1,46	0,85	71	4.490	8	-	-	FI 0,75kW 2,2A
DRIEFASIG 4 POLEN											
HCFT/4-250/H	1365	250	73	0,3	0,2	49	1.110	5	-	SPTM 3-2	FI 0,75kW 2,2A
HCFT/4-315/H	1340	315	124	0,5	0,3	55	2.170	7	-	SPTM 3-2	FI 0,75kW 2,2A
HCFT/4-355/H	1385	355	171	0,9	0,5	59	3.550	8	-	SPTM 3-2	FI 0,75kW 2,2A
HCFT/4-400/H	1370	400	250	1,0	0,6	62	4.790	9	-	SPTM 3-2	FI 0,75kW 2,2A
HCFT/4-450/H	1380	450	449	1,4	0,8	65	6.640	13	-	SPTM 3-2	FI 0,75kW 2,2A
HCFT/4-500/H	1460	500	767	3,5	2,0	68	9.750	16	-	SPTM 3-3	FI 0,75kW 2,2A
HCFT/4-560/H	1390	560	1051	3,8	2,2	70	12.500	22	-	SPTM 3-3	FI 0,75kW 2,2A
HCFT/4-630/H	1425	630	1582	5,0	2,9	73	17.900	25	-	-	FI 1,5kW 4,1A
HCFT/4-710/H	1375	710	2413	7,4	4,3	74	22.140	27	-	-	FI 2,2kW 5,8A
HCFT/4-800/L-X-1,5	1420	800	2308	6,6	3,8	78	22.780	37	-	-	FI 1,5kW 4,1A
HCFT/4-800/H-X-3	1450	800	4344	12,5	7,2	84	33.410	52	-	-	FI 4,0kW 9,5A
HCFT/4-900/L-X-3	1460	900	3845	11,3	6,5	82	25.550	94	-	-	FI 4,0kW 9,5A
HCFT/4-900/H-X-5,5	1460	900	7090	12,30	8,7	87	45.550	110	-	-	FI 5,5kW 14A
HCFT/4-1000/L-X-3	1440	1000	5098	14,2	8,2	86	38.800	67	-	-	FI 4,0kW 9,5A
HCFT/4-1000/H-X-5,5	1450	1000	8053	13,5	9,3	93	47.370	95	-	-	FI 5,5kW 14A
DRIEFASIG 6 POLEN											
HCFT/6-355/H	925	355	83	0,3	0,2	48	2.260	8	-	SPTM 3-2	FI 0,75kW 2,2A
HCFT/6-400/H	880	400	107	0,5	0,3	51	3.070	9	-	SPTM 3-2	FI 0,75kW 2,2A
HCFT/6-450/H	910	450	146	0,5	0,3	54	4.440	13	-	SPTM 3-2	FI 0,75kW 2,2A
HCFT/6-500/H	920	500	240	1,0	0,6	57	6.350	16	-	SPTM 3-2	FI 0,75kW 2,2A
HCFT/6-560/H	925	560	337	1,2	0,7	59	8.320	22	-	SPTM 3-2	FI 0,75kW 2,2A
HCFT/6-630/H	920	630	534	2,1	1,2	62	11.400	25	-	SPTM 3-2	FI 0,75kW 2,2A
HCFT/6-710/G	955	710	888	4,5	2,6	65	16.260	27	-	SPTM 3-5	FI 1,5kW 4,1A
HCFT/6-800/L-X-0,55	940	800	1042	3,5	2,0	73	18.310	31	-	-	FI 0,75kW 2,2A
HCFT/6-800/H-X-0,75	945	800	1160	3,8	2,2	75	19.960	36	-	-	FI 0,75kW 2,2A
HCFT/6-900/L-X-1,1	965	900	1266	4,7	2,7	74	23.160	86	-	-	FI 1,5kW 4,1A
HCFT/6-900/H-X-1,5	955	900	2202	7,1	4,1	78	31.720	93	-	-	FI 1,5kW 4,1A
HCFT/6-1000/L-X-1,1	940	1000	1749	5,7	3,3	79	28.970	54	-	-	FI 1,5kW 4,1A
HCFT/6-1000/H-X-1,5	945	1000	2627	8,1	4,7	84	37.980	62	-	-	FI 2,2kW 5,8A

* Geluiddruk gemeten in vrije veld condities, op een afstand equivalent aan 3 maal de diameter van de waaier, met een minimum van 1,5 meter.

** De driefaseregelaars (SPTM-2) of frequency regelaar (VFKB / VFTM) worden aanbevolen bij 400 V

TYPEVERKLARING

H	C	F	T	/	4	-	4	0	0	/	H	A					8	9	
1	2	3	4		5		6				7								

1 - H: Axiale muurventilator.

2 - C: Serie letter.

3 - Soort waaier:

F: Ø 250-Ø 630 Kunststof waaier met vaste schoepen.
Ø 710 - Ø 1000 Waaier met aluminium naaf + verstelbare kunststof schoepen.

G: Kunststof waaier met verstelbare schoepen.

B: Ø 250-Ø 400 Aluminium waaier met vaste schoepen Ø 450 - Ø 1000 Aluminium waaier met verstelbare schoepen.

4 - Spanning:

B: Enkelfasig.

T: Driefasig.

5 - Aantal polen:

2: [ca. 2900 tpm - 50 Hz]

4: [ca. 1400 tpm - 50 Hz]

6: [ca. 900 tpm - 50 Hz]

6 - Nominale waaierdiameter: (mm)

7 - Schoephoek.

H: Hoog.

B: Laag.

8 - Luchtrichting:

A: Motor-Waaier.

9 - Speciale modellen:

X: Steun zonder beschermrooster.

L: Speciaal voor buitenmontage.

C: Condensgaten.

EX: Explosieveilige uitvoeringen overeenkomstig ATEX richtlijn voor 3 fase ventilatoren:

-EXE: Verhoogde bescherming

⊕ IIG EExeIIT3

-EXD: Vlambestendig voor 800 en 1000 modellen. ⊕ IIG EExdIIBT5 of EExdIICT4

G: Verhoogde corrosiebescherming voor toepassing op landbouwbedrijven.

TF: met roestwerende Teflon coating.

TOEPASSING - ELEKTRISCHE AANSLUITING



Spanning	Motor voeding	Aansluiting	Toerental
ENKELFASE 220V 50Hz, 240V 50Hz	230V 50Hz	See wiring diagram	Hoog
DRIEFASE 220V 50Hz 240V 50Hz	230/400V 50Hz		Hoog
			Laag*
DRIEFASE 380V 50Hz 415V 50Hz	230/400V 50Hz		Hoog
	400V 50Hz		Hoog
			Laag*

* Van 450 tot 630 mm diameter.

GELUIDSDRUK GEGEVENS

Geluidsdruckspectra in dB(A) per frequentieband in Hz: Het geluidniveau dat in de technische tabellen van de S&P-ventilatoren wordt weergegeven, komt in het algemeen overeen met een druk in dB(A), gemeten in het vrije veld op een afstand die equivalent is met drie keer de waaier diameter met een minimum van 1,5 m bij de waaier ventilatoren, en op een afstand van 1,5 m bij de andere ventilatoren, behalve anders vermeld.

Model	63	125	250	500	1000	2000	4000	8000	LwA
HCGB/2-315	50	61	68	70	72	69	64	58	77
HCGT/2-315	55	66	73	75	77	74	69	63	82
HCGB/2-355	55	66	73	75	77	74	69	63	82
HCGT/2-355	55	70	69	77	82	78	73	66	85

Model	63	125	250	500	1000	2000	4000	8000	LwA
/4-250/H	31	45	52	57	58	57	52	44	63
/4-315/H	42	53	60	62	64	61	56	50	69
/4-355/H	43	58	57	65	70	66	61	54	73
/4-400/H	48	61	62	68	73	69	66	57	76
/4-450/H	46	65	62	68	75	74	69	62	79
/4-500/H	49	68	68	74	78	76	72	65	82
/4-560/H	57	70	74	78	80	78	74	67	85
/4-630/H	57	72	76	81	85	82	79	72	89
/4-710/H	58	75	83	85	87	85	81	72	92
/4-800/L	58	77	87	93	93	89	83	76	97
/4-800/H	64	83	93	99	99	95	89	82	103
/4-900/L	59	81	91	97	98	94	88	80	102
/4-900/H	64	86	96	102	103	99	93	85	107
/4-1000/L	62	85	95	101	102	98	93	84	106
/4-1000/H	69	92	102	107	109	105	100	90	113

Model	63	125	250	500	1000	2000	4000	8000	LwA
/6-315/H	32	43	50	52	54	51	46	40	59
/6-355/H	32	47	46	54	59	55	50	43	62
/6-400/H	37	50	51	57	62	58	55	46	65
/6-450/H	35	54	51	57	64	63	58	51	68
/6-500/H	38	57	57	63	67	65	61	54	71
/6-560/H	46	59	63	67	69	67	63	56	74
/6-630/H	46	61	65	70	74	71	68	61	78
/6-710/H	49	66	74	76	78	76	72	63	83
/6-800/L	52	71	81	87	87	83	77	70	91
/6-800/H	54	73	83	89	89	85	79	72	93
/6-900/L	51	73	83	89	90	86	80	72	94
/6-900/H	55	77	87	93	94	90	84	76	98
/6-1000/L	56	78	89	94	96	92	86	77	100
/6-1000/H	60	83	93	99	100	96	91	82	104

AFMETINGEN (mm)

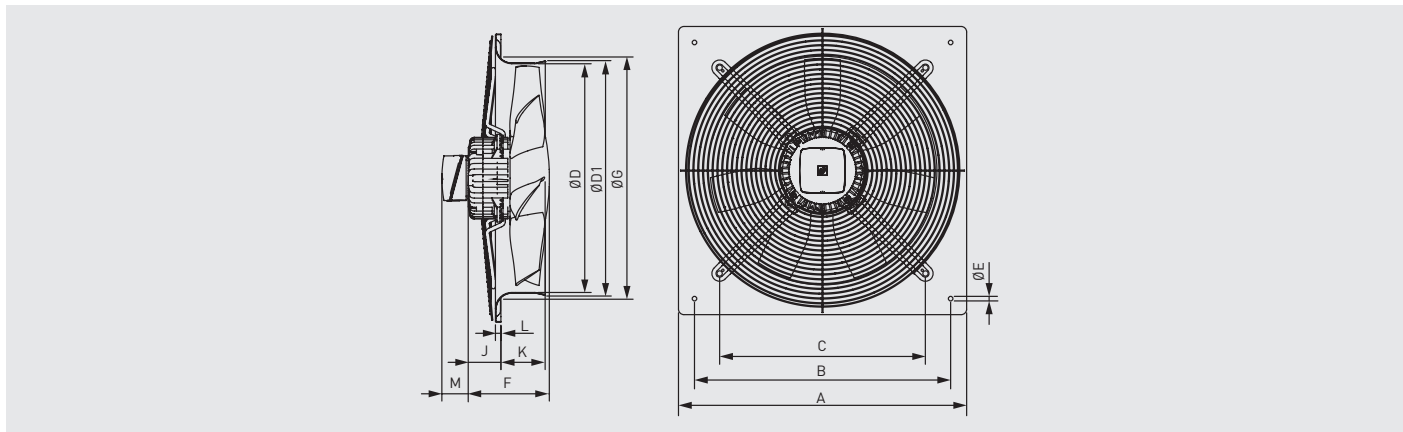

Model	A	B	C	Ø D	Ø D1	Ø E	F			Ø G	J			K	L	M	
							Aantal polen				Aantal polen					Drief.	Eenf.
							/2	/4	/6		/2	/4	/6				
250	315	260	220	254	261	10		122		294		59		53	12	60	65
315	400	330	280	315	320	10	129	122	122	329	45	32	32	68	12	60	65
355	450	380	315	355	363	10	129	129	129	371	45	45	45	75	12	60	65
400	500	420	355	400	410	10		129	129	422		40,5	40,5	78	12	60	65
450	560	480	400	450	457	10		150	150	476		48	48	91	12	60	65
500	630	560	450	500	512	10		150	150	536		44,5	44,5	97	12	60	65
560	710	630	510	560	570	10		218,5	150	596		110,5	42	98,5	12	60	65
630	800	710	580	630	640	12		218,5	150	674		110,5	41	103	12	60	65
710	900	800	636	710	720	12		220	218,5	733		114	134	91,5	16,5	60	65

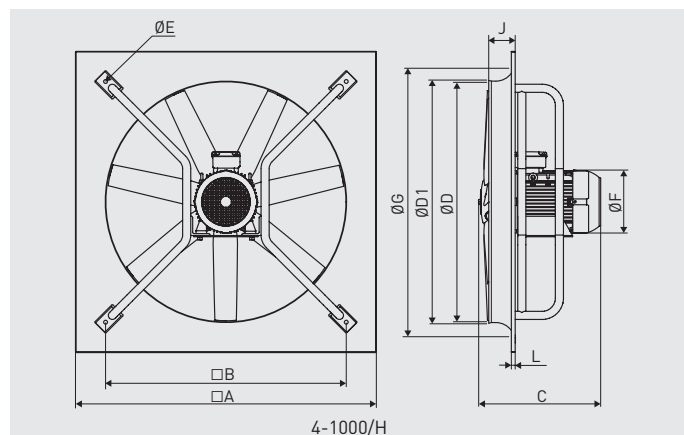
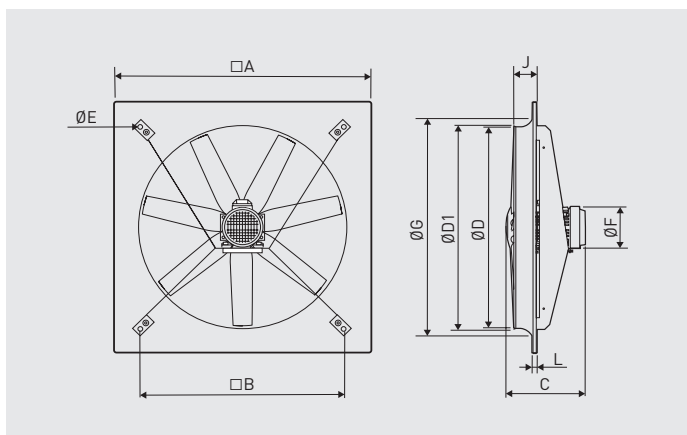

Modelo	A	B	Ø D	Ø D1	Ø E	J	Ø G	C				Ø F			
								/4		/6		/4		/6	
								L	H	L	H	L	H	L	H
800	1000	800	800	810	18	92	926	363	442	318	363	180	200	160	180
900	1120	900	900	910	18	120	1060	442	512	400	400	200	280	200	200
1000	1250	1000	1000	1010	18	110	1154	442	-	345	400	200	-	200	200
4-1000/H	1250	1000	1000	1010	16	110	1154	-	512	-	-	-	280	-	-

MONTAGE ACCESSOIRES

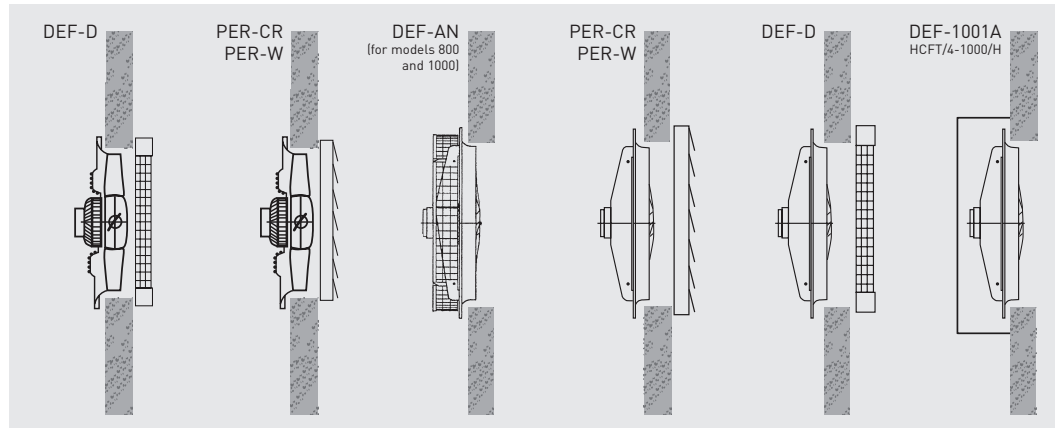
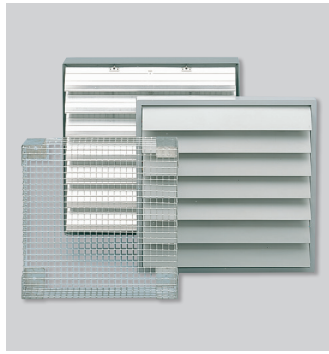

Model HCFB/HCFT HCBB/HCBT	Beschermroosters		Zelfsluitende jaloeziekleppen		
	Uitblaas	Aanzuig	Kunststof	Aluminium	ATEX versie*
250	DEF-250 D	-	PER-250 W	PER-250 CR	PER-315 Ex
315	DEF-325 D	-	PER-355 W	PER-355 CR	PER-315 Ex
355	DEF-375 D	-	PER-355 W	PER-355 CR	PER-355 Ex
400	DEF-450 D	-	PER-400 W	PER-400 CR	PER-400 Ex
450	DEF-450 D	-	PER-450 W	PER-450 CR	PER-450 Ex
500	DEF-525 D	-	PER-500 W	PER-500 CR	PER-500 Ex
560	DEF-630 D	-	PER-560 W	PER-630 CR	PER-560 Ex
630	DEF-630 D	-	PER-630 W	PER-630 CR	PER-630 Ex
710	DEF-800 D	-	PER-710 W	PER-710 CR	PER-710 Ex
800	DEF-800 D	DEF-800 AN	PER-800 W	PER-800 CR	-
/4-900/H	DEF-1000 D	DEF-900 AN	PER-1000 W	PER-1000 CR	-
/4-900/L	DEF-1000 D	DEF-901 AN	PER-1000 W	PER-1000 CR	-
/6-900	DEF-1000 D	DEF-901 AN	PER-1000 W	PER-1000 CR	-
1000	DEF-1000 D	DEF-1000 AN	PER-1000 W	PER-1000 CR	-
4-1000 / H	DEF-1000 D	DEF-1001 AN	PER-1000 W	PER-1000 CR	-

* Alleen te gebruiken in combinatie met HCBT ex. versie. Voor meer informatie zie montagesaccessoires.

ELEKTRISCHE ACCESSOIRES



REB-1N / REB-2,5N
 Enkelfasige elektronische toerenregelaars.



**REB-5
 REB-10**
 Enkelfasige elektronische toerenregelaar.



SPTM
 Transformatorregelaars enkelfasig en driefasig.

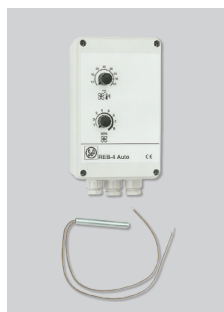

REB-4 Auto
 Enkelfasige elektronische toerenregelaar. Met temperatuursensor.



FI IP20
 Programmeerbare frequentieregelaar IP20, in te bouwen in regelkast. Standaard voorzien van EMC-filter.



FI IP66
 Programmeerbare frequentieregelaar IP66, hoeft niet in regelkast gemonteerd te worden. Standaard voorzien van EMC-filter.



COM D/S
 Ster / Driehoekschakelaar.

GRAFIEKEN - HCFB/HCFT - HCBB/HCBT

- q_v : Luchtvolume in m^3/h en m^3/s .
- p_{sf} : Statische druk in Pa.
- p_g : Veiligheidsrooster drukverlies in Pa.
- SFP: Specifiek vermogen $W/m^3/s$.
- P: Ogenomen vermogen in W.
- Meet categorie: A.
- Efficiency categorie: statisch.
- Ventilator rendement zonder toeren regeling.
- Ventilator getest zonder rooster.
- Luchtstroom data in overeenstemming met ISO 5801.
- Geluidsdruk $L_p(A)$ gemeten in vrije veld conditie op een afstand gelijk aan 3x de diameter met een minimum van 1,5 m.

Selecteer de luchtcapaciteit in de grafiek, rechts van de stippellijn.

- MC** Maatvoering categorie
- EC** Rendements categorie
- VSD** Snelheidsregeling: geleverd bij de ventilator
- SR** Specifieke ratio
- η [%]** Totaal rendement
- N** Rendement
- [kW]** Ogenomen vermogen
- [m^3/h]** Lucht volume
- [Pa]** Statische druk
- [RPM]** Snelheid

HCGB/2-315/L

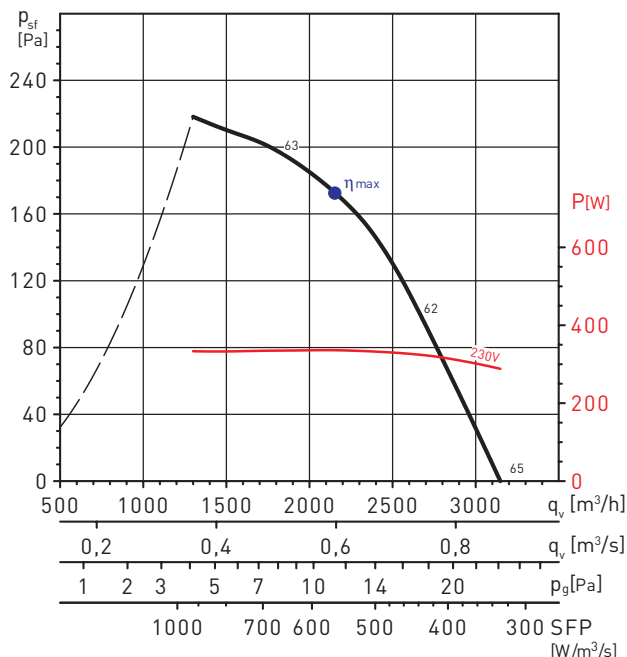

MC	EC	VSD	SR	η [%]	N	[kW]	[m^3/h]	[Pa]	[RPM]
A	Static	No	1	30,8	40,1	0,336	2106	177	2597

HCGB/2-355/J

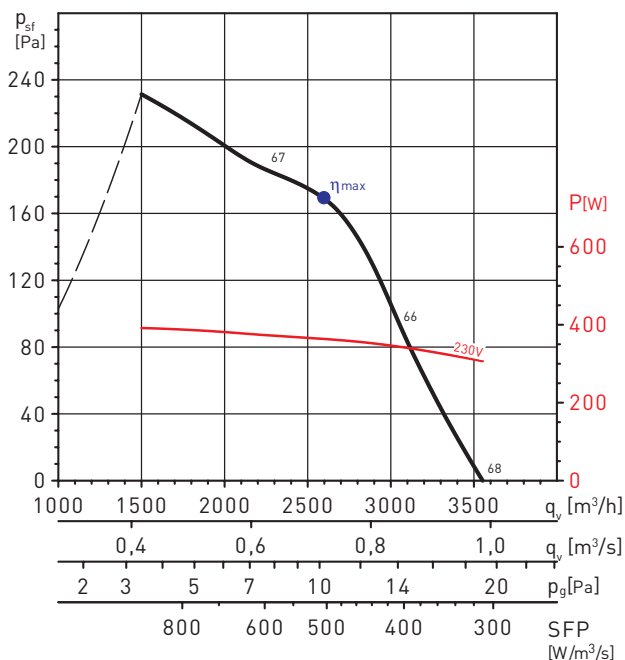

MC	EC	VSD	SR	η [%]	N	[kW]	[m^3/h]	[Pa]	[RPM]
A	Static	No	1	33,8	42,9	0,364	2597	169	2590

HCGT/2-315/L

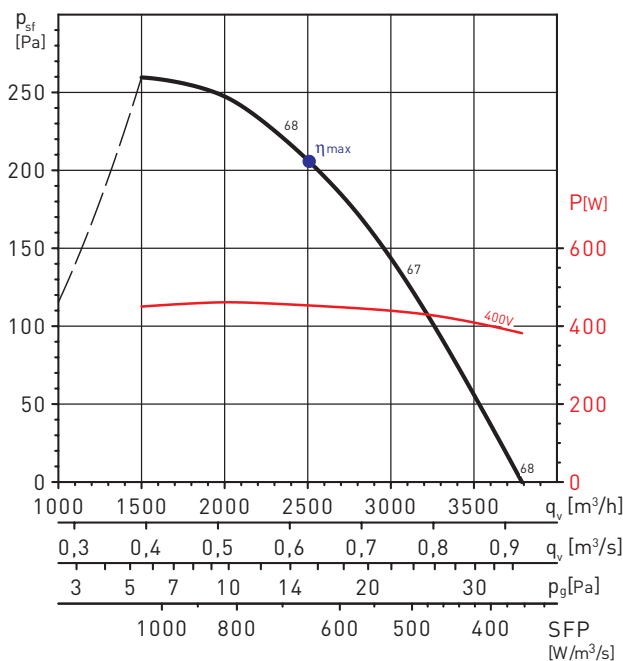

MC	EC	VSD	SR	η [%]	N	[kW]	[m^3/h]	[Pa]	[RPM]
A	Static	No	1	31,7	40,2	0,455	2440	212	2543

GRAFIEKEN - 2 POLEN

HCGT/2-355/I

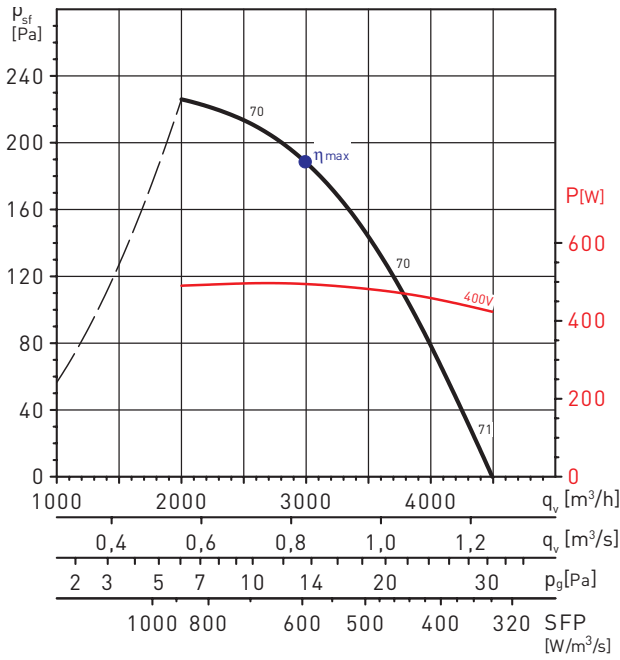

MC	EC	VSD	SR	η [%]	N	[kW]	[m³/h]	[Pa]	[RPM]
A	Static	No	1	31,7	40,0	0,495	2997	188	2454

HCFB/4-250/H

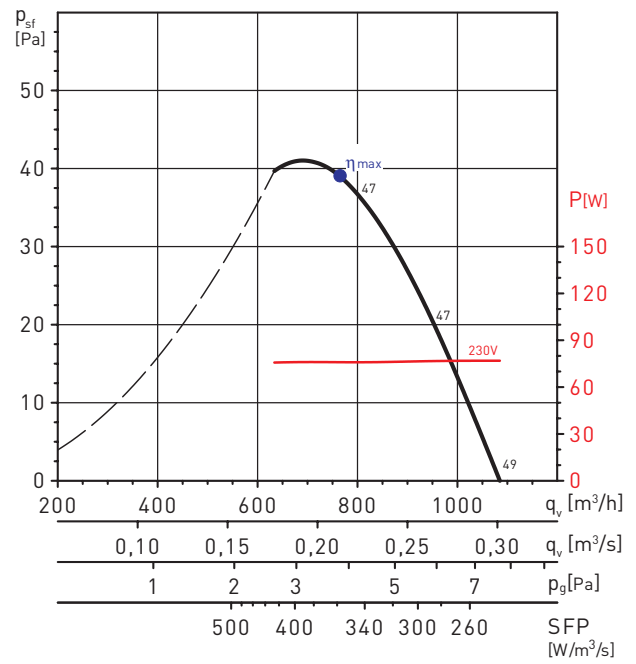

HCFB/4-315/H

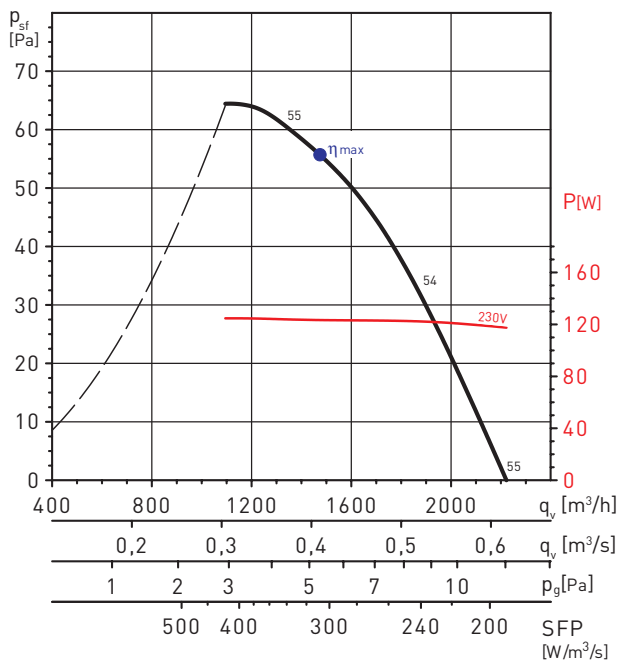

HCFB/4-355/H

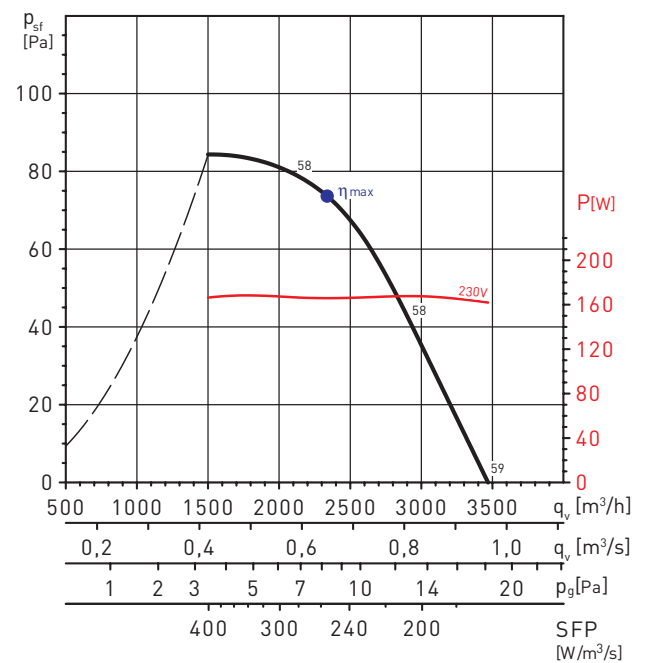

MC	EC	VSD	SR	η [%]	N	[kW]	[m³/h]	[Pa]	[RPM]
A	Static	No	1	28,8	40,1	0,166	2339	74	1406

GRAFIEKEN - 4 POLEN

HCFB/4-400/H

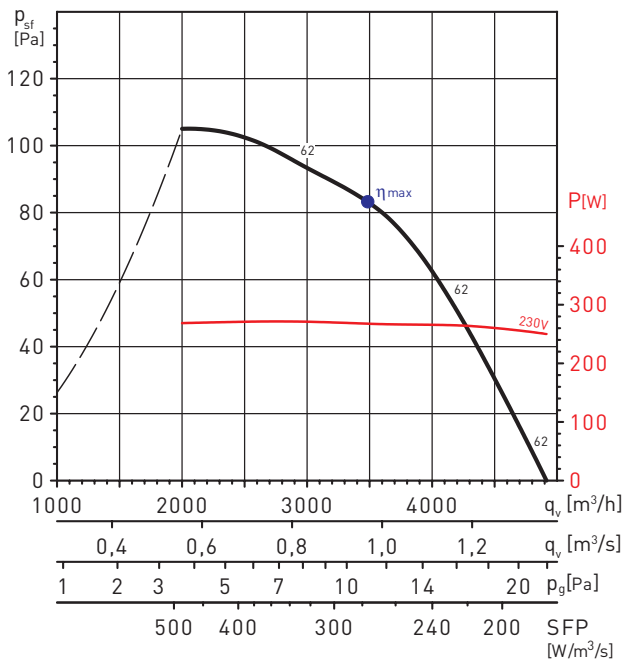

MC	EC	VSD	SR	η [%]	N	[kW]	[m³/h]	[Pa]	[RPM]
A	Static	No	1	30,1	40,0	0,268	3488	83	1411

HCFB/4-450/H

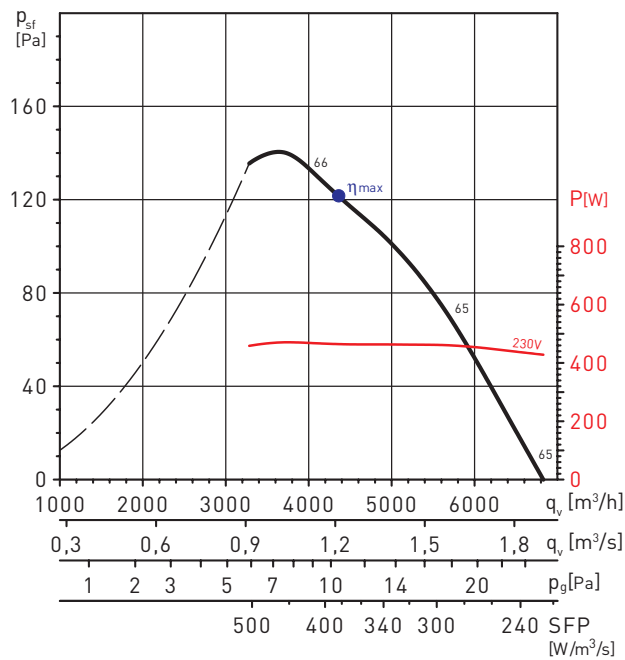

MC	EC	VSD	SR	η [%]	N	[kW]	[m³/h]	[Pa]	[RPM]
A	Static	No	1	31,7	40,1	0,466	4214	126	1351

HCFB/4-500/H

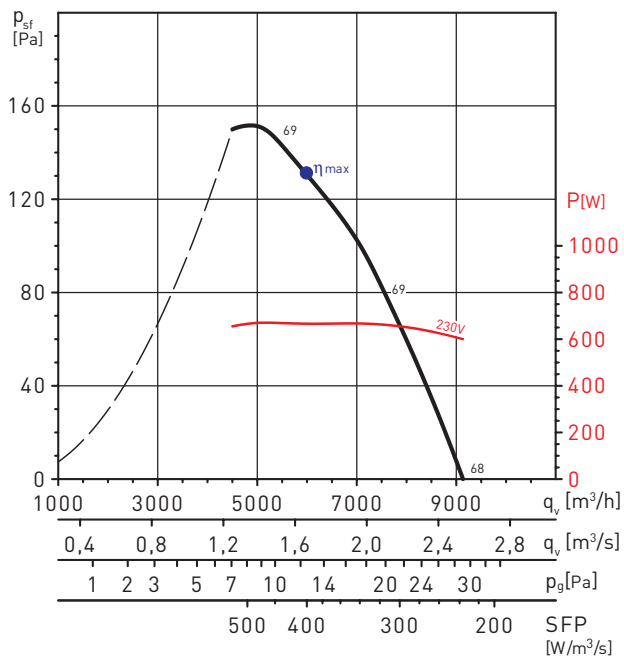

MC	EC	VSD	SR	η [%]	N	[kW]	[m³/h]	[Pa]	[RPM]
A	Static	No	1	32,8	40,2	0,667	5735	137	1351

HCFB/4-560/H

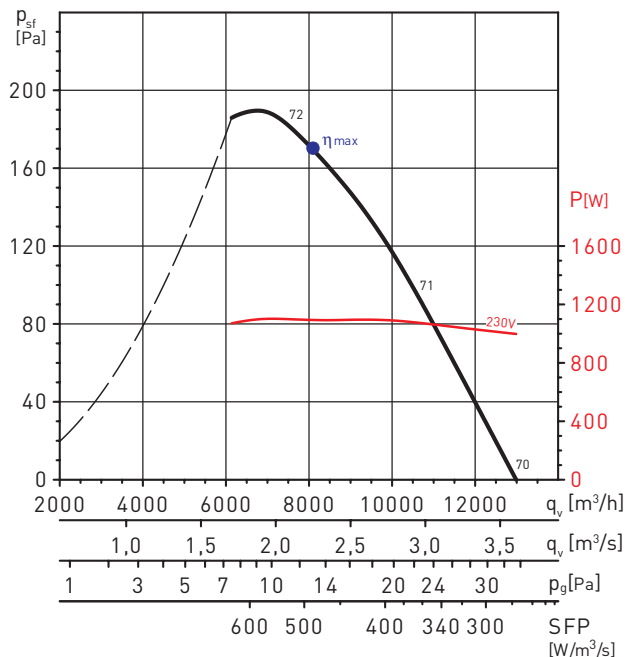

MC	EC	VSD	SR	η [%]	N	[kW]	[m³/h]	[Pa]	[RPM]
A	Static	No	1	34,9	41,0	1,093	8081	170	1386

GRAFIEKEN - 4 POLEN

HCFB/4-630/H

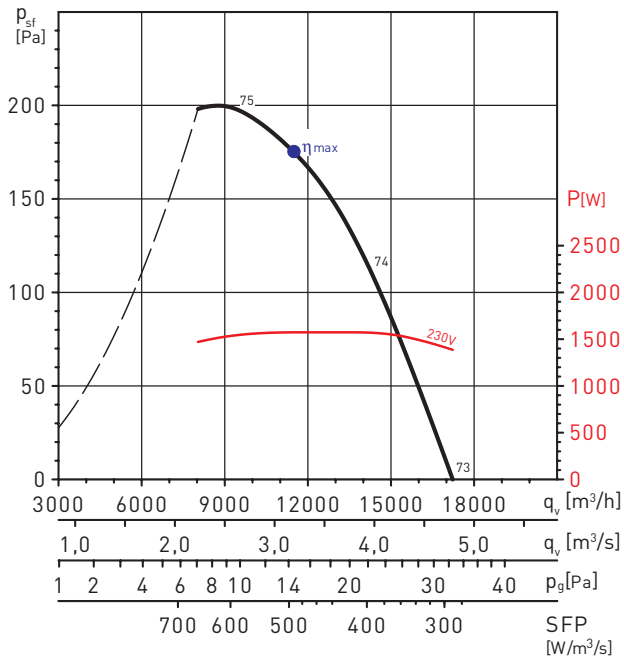

MC	EC	VSD	SR	η [%]	N	[kW]	[m³/h]	[Pa]	[RPM]
A	Static	No	1	35,5	40,6	1,573	11483	175	1345

HCFT/4-250/H

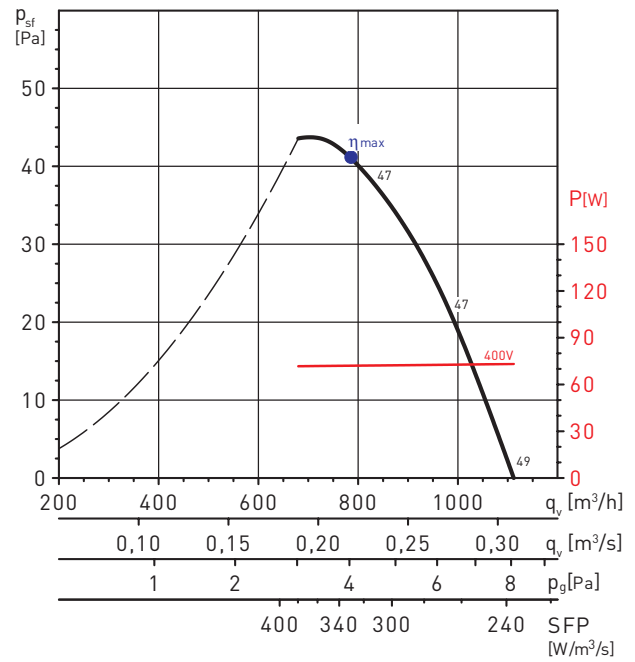

HCFT/4-315/H

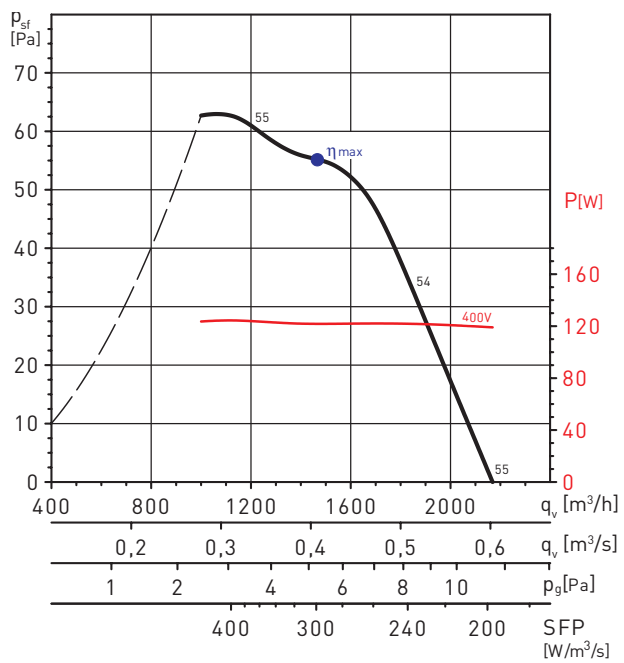

HCFT/4-355/H

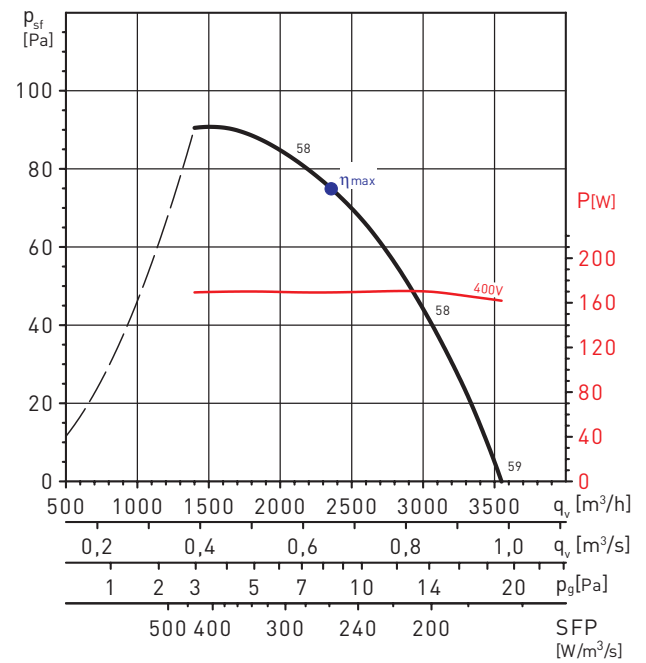

MC	EC	VSD	SR	η [%]	N	[kW]	[m³/h]	[Pa]	[RPM]
A	Static	No	1	29,0	40,2	0,169	2331	76	1379

GRAFIEKEN - 4 POLEN

HCFT/4-400/H

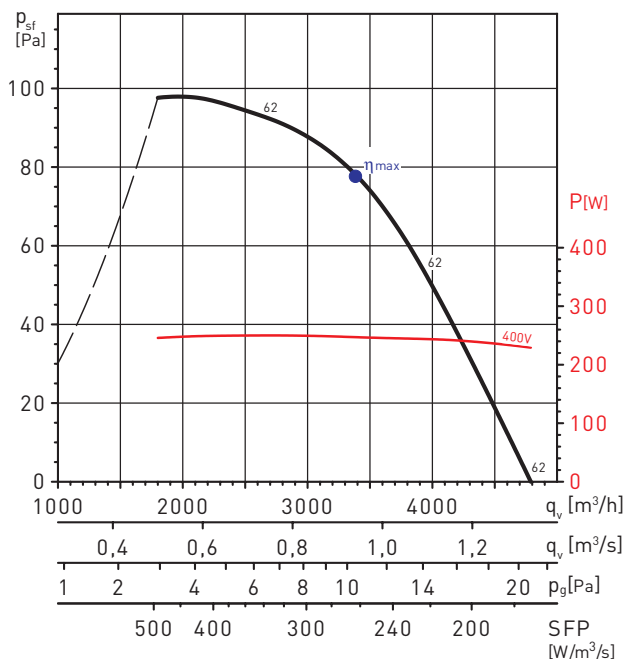

MC	EC	VSD	SR	η [%]	N	[kW]	[m³/h]	[Pa]	[RPM]
A	Static	No	1	29,8	40,0	0,248	3257	82	1354

HCFT/4-450/H

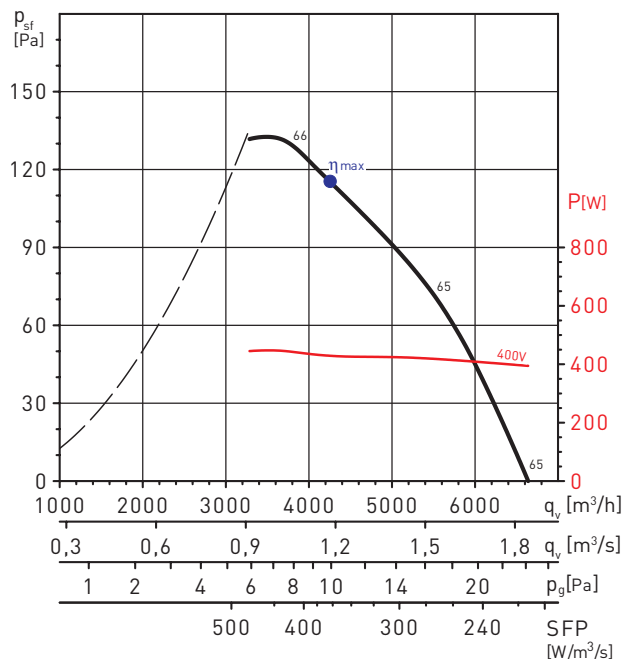

MC	EC	VSD	SR	η [%]	N	[kW]	[m³/h]	[Pa]	[RPM]
A	Static	No	1	31,8	40,5	0,429	4261	115	1351

HCFT/4-500/H

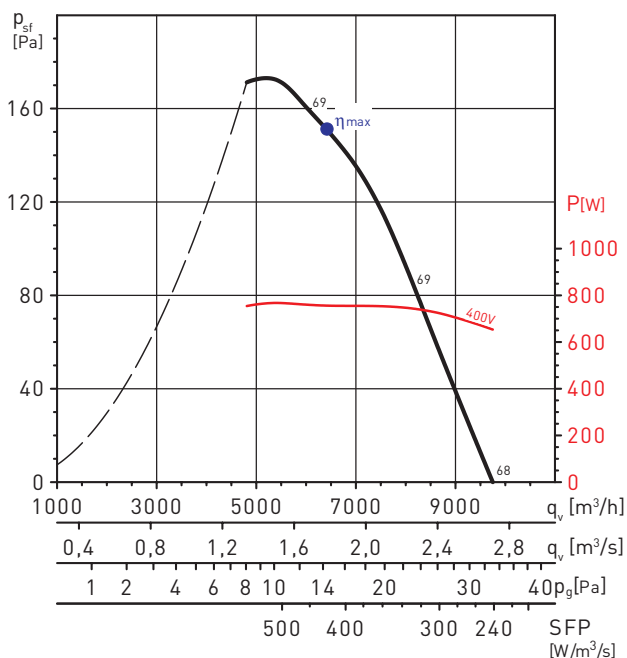

MC	EC	VSD	SR	η [%]	N	[kW]	[m³/h]	[Pa]	[RPM]
A	Static	No	1	35,7	42,8	0,756	6476	150	1449

HCFT/4-560/H

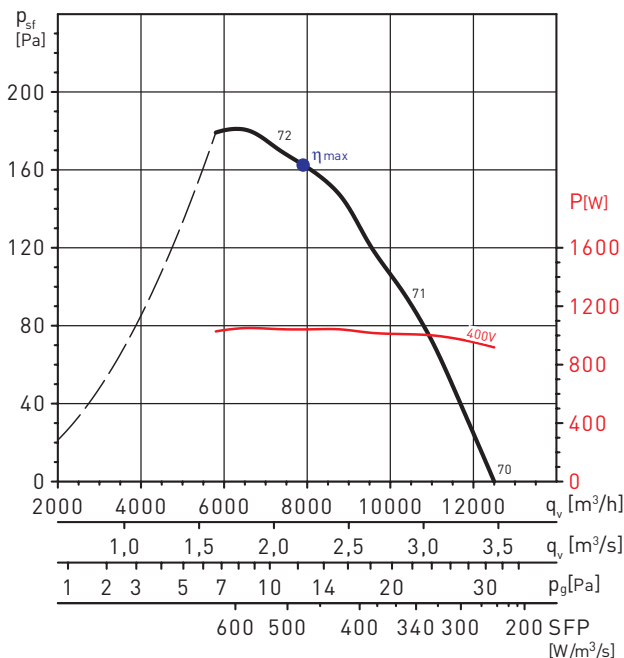

MC	EC	VSD	SR	η [%]	N	[kW]	[m³/h]	[Pa]	[RPM]
A	Static	No	1	34,9	41,1	1,045	8422	156	1377

GRAFIEKEN - 4 POLEN

HCFT/4-630/H

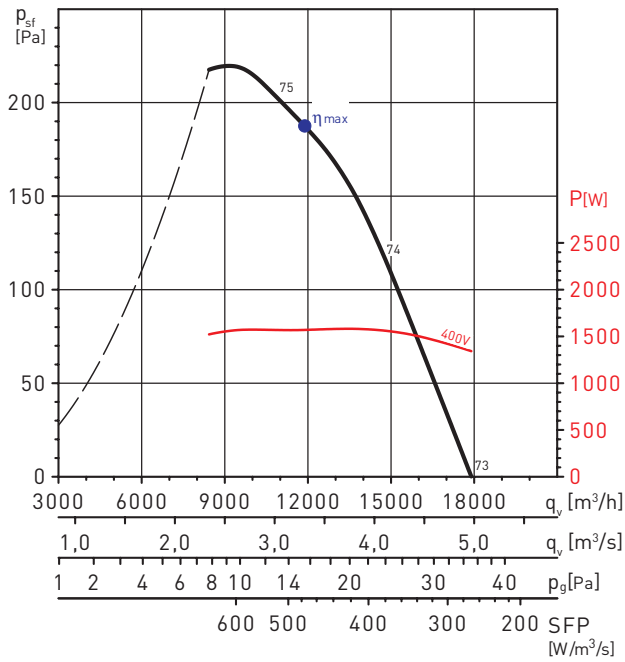

MC	EC	VSD	SR	η [%]	N	[kW]	[m³/h]	[Pa]	[RPM]
A	Static	No	1	39,5	44,6	1,569	11760	189	1404

HCFT/4-710/H

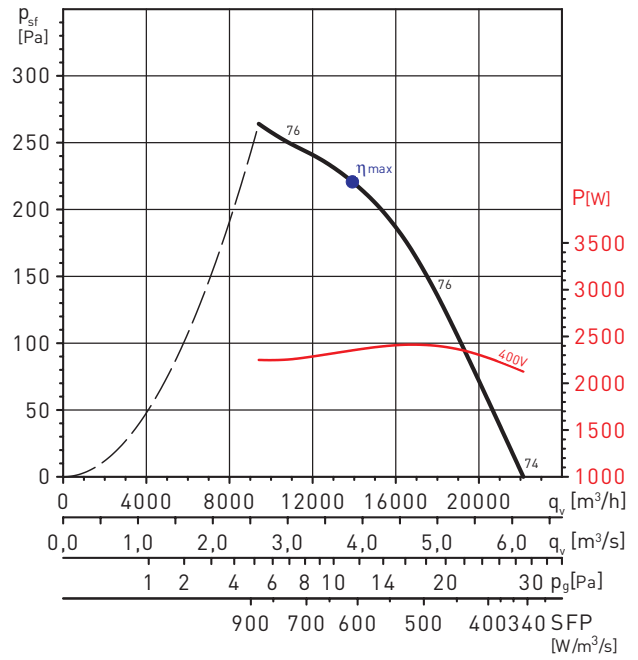

MC	EC	VSD	SR	η [%]	N	[kW]	[m³/h]	[Pa]	[RPM]
A	Static	No	1	36,3	40,3	2,352	13929	221	1354

HCFT/4-800/L

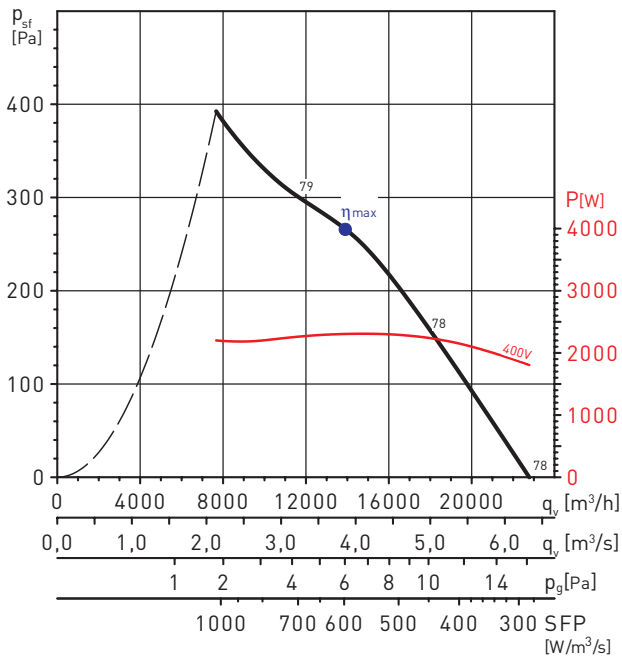

MC	EC	VSD	SR	η [%]	N	[kW]	[m³/h]	[Pa]	[RPM]
A	Static	No	1	44,7	48,7	2,305	13900	266	1392

HCFT/4-800/H

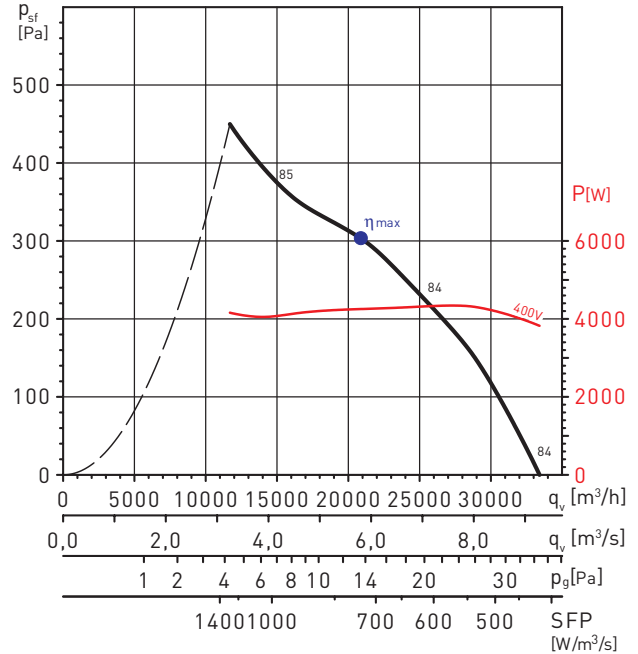

MC	EC	VSD	SR	η [%]	N	[kW]	[m³/h]	[Pa]	[RPM]
A	Static	No	1	41,4	43,8	4,253	20873	304	1435

GRAFIEKEN - 4 POLEN

HCFT/4-900/L

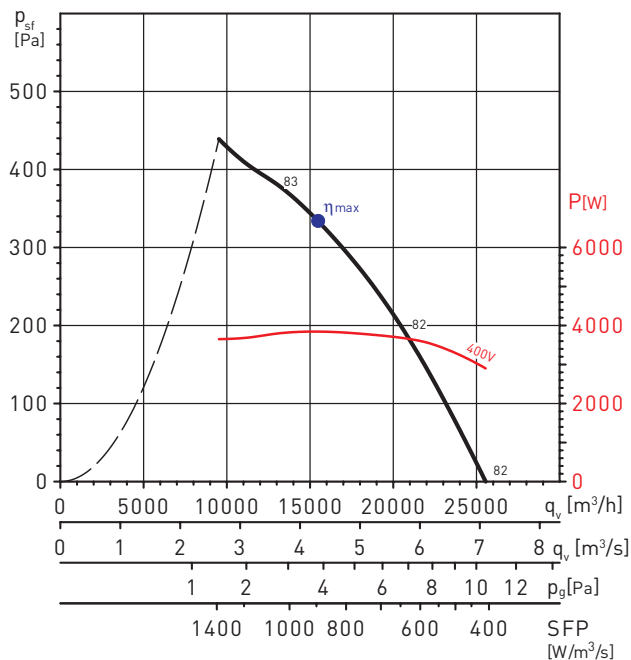

MC	EC	VSD	SR	η[%]	N	[kW]	[m³/h]	[Pa]	[RPM]
A	Static	No	1	37,4	40,0	3,844	15455	334	1442

HCFT/4-900/H

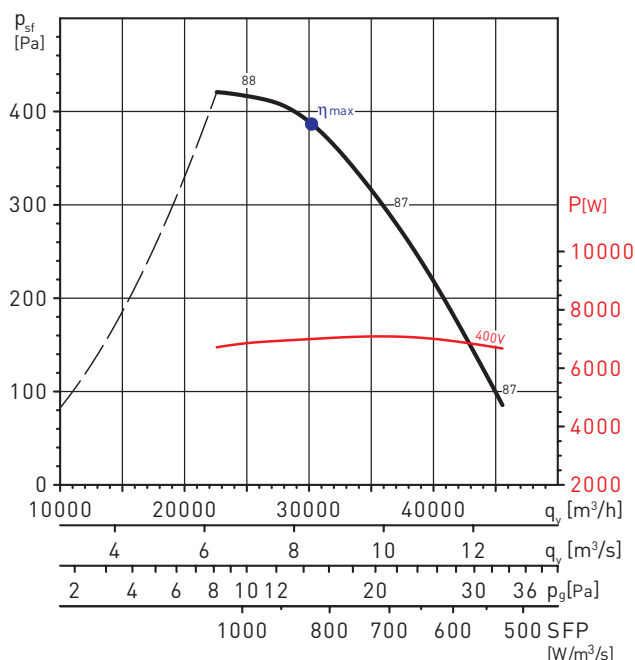

MC	EC	VSD	SR	η[%]	N	[kW]	[m³/h]	[Pa]	[RPM]
A	Static	No	1	46,3	47,3	7,001	30198	387	1455

HCFT/4-1000/L

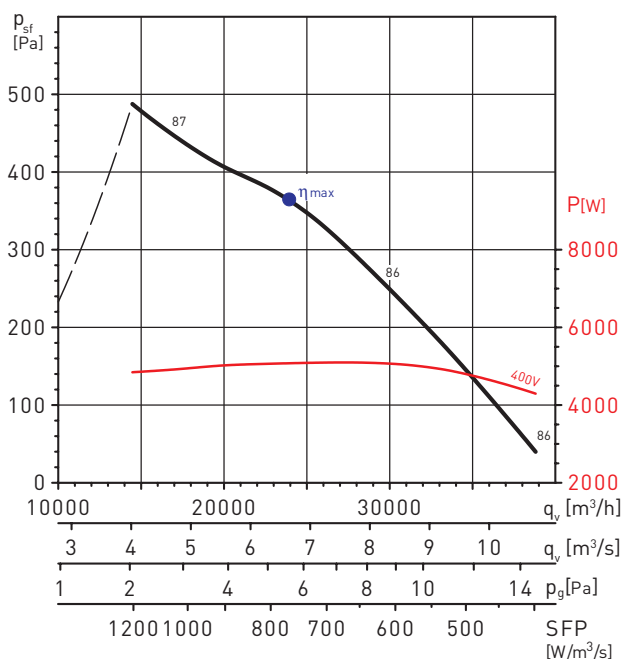

MC	EC	VSD	SR	η[%]	N	[kW]	[m³/h]	[Pa]	[RPM]
A	Static	No	1	47,6	49,5	5,076	23915	364	1421

HCFT/4-1000/H

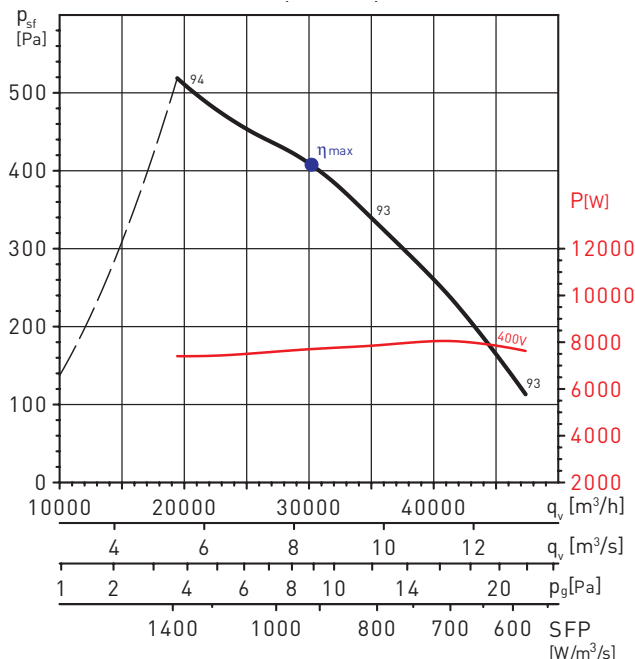

MC	EC	VSD	SR	η[%]	N	[kW]	[m³/h]	[Pa]	[RPM]
A	Static	No	1	44,4	45,1	7,706	30194	408	1438

GRAFIEKEN - 6 POLEN

HCFB/6-315/H

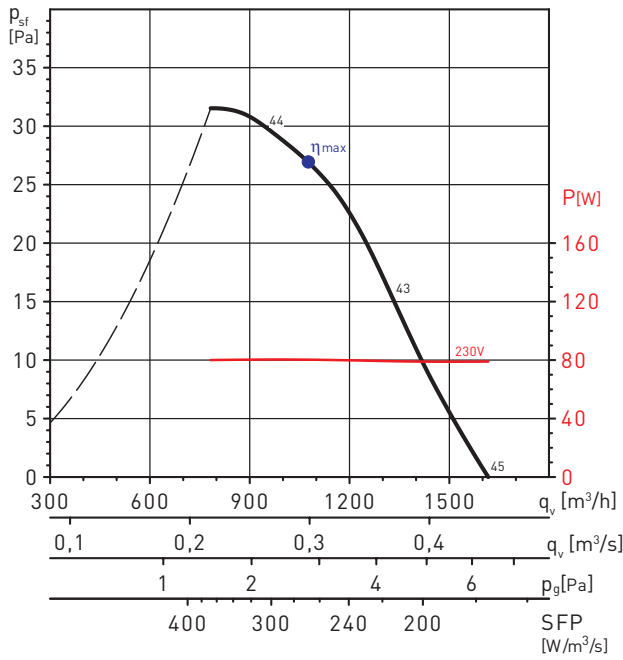

HCFB/6-355/H

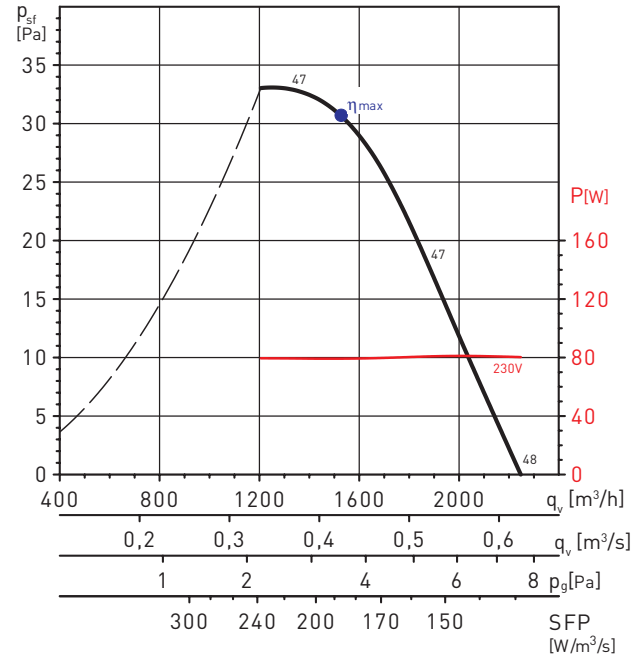

HCFB/6-400/H

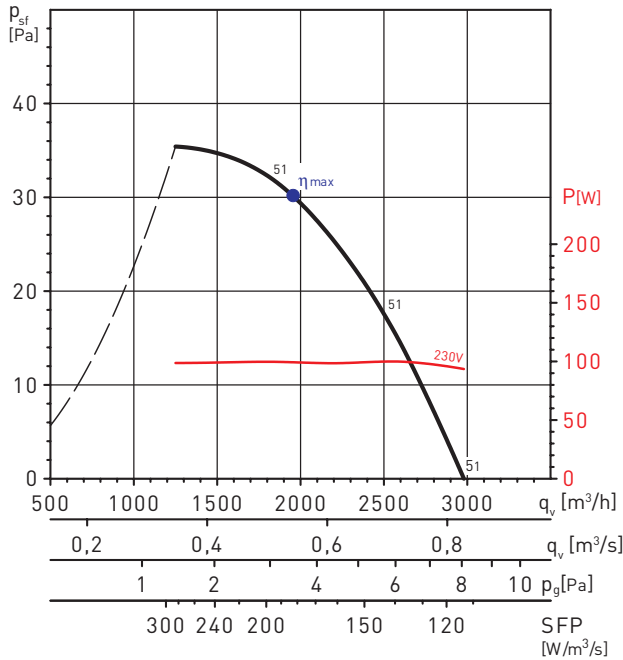

HCFB/6-450/H

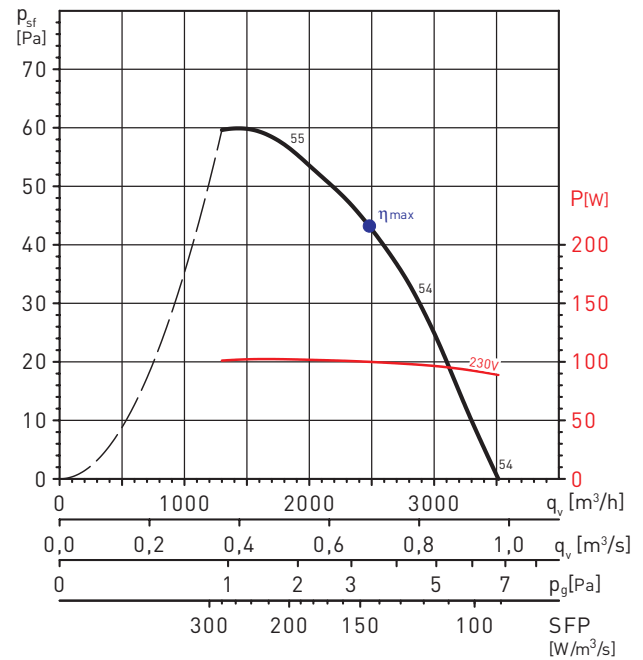

MC	EC	VSD	SR	η [%]	N	[kW]	[m^3/h]	[Pa]	[RPM]
A	Static	No	1	30,2	42,8	0,101	2327	47	885

GRAFIEKEN - 6 POLEN

HCFB/6-500/H

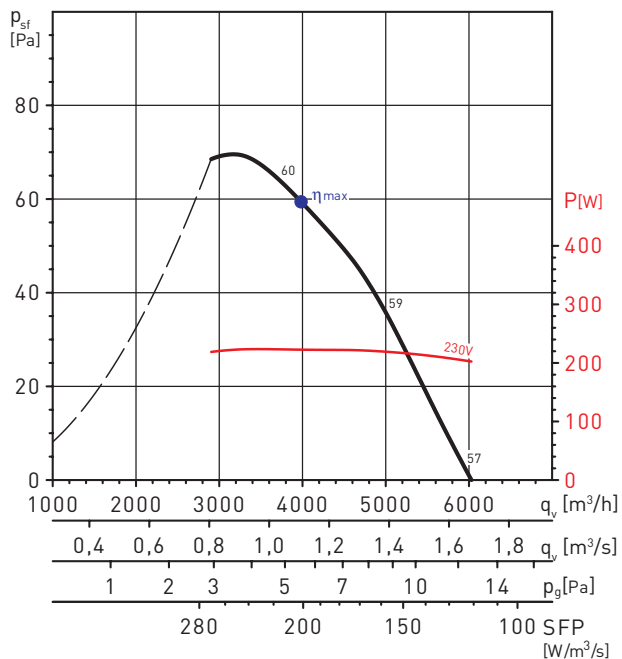

MC	EC	VSD	SR	η [%]	N	[kW]	[m³/h]	[Pa]	[RPM]
A	Static	No	1	29,7	40,1	0,223	3783	63	904

HCFB/6-560/H

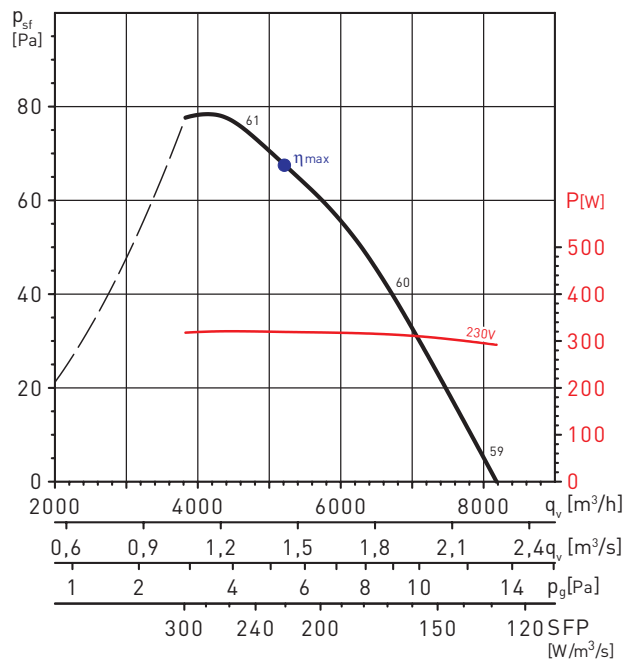

MC	EC	VSD	SR	η [%]	N	[kW]	[m³/h]	[Pa]	[RPM]
A	Static	No	1	30,7	40,2	0,319	5214	68	880

HCFB/6-630/H

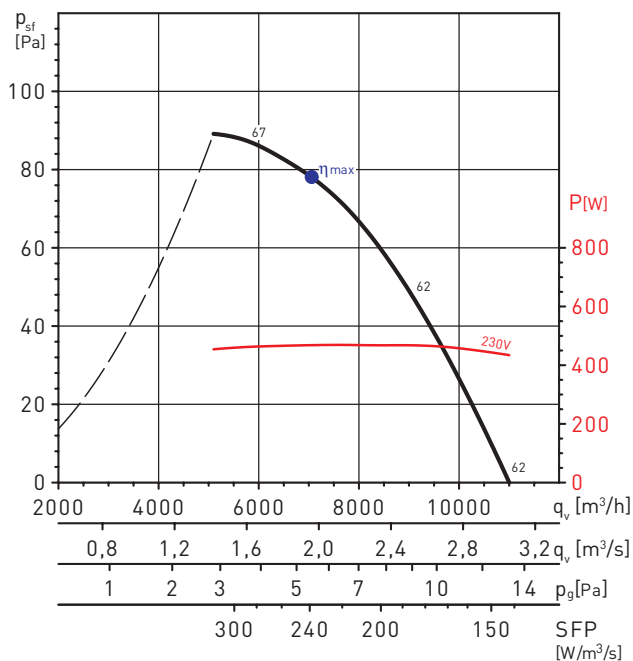

MC	EC	VSD	SR	η [%]	N	[kW]	[m³/h]	[Pa]	[RPM]
A	Static	No	1	32,7	41,1	0,469	7230	76	899

HCFT/6-355/H

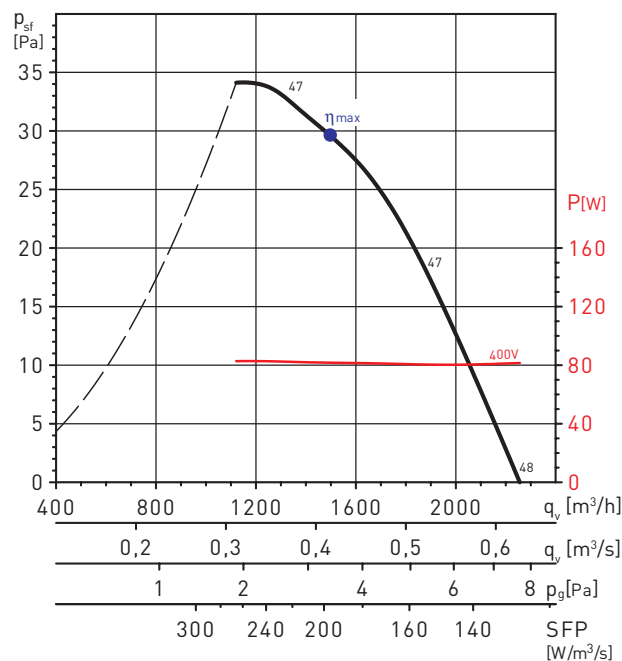

MC	EC	VSD	SR	η [%]	N	[kW]	[m³/h]	[Pa]	[RPM]
A	Static	No	1	32,7	41,1	0,469	7230	76	899

GRAFIEKEN - 6 POLEN

HCFT/6-400/H

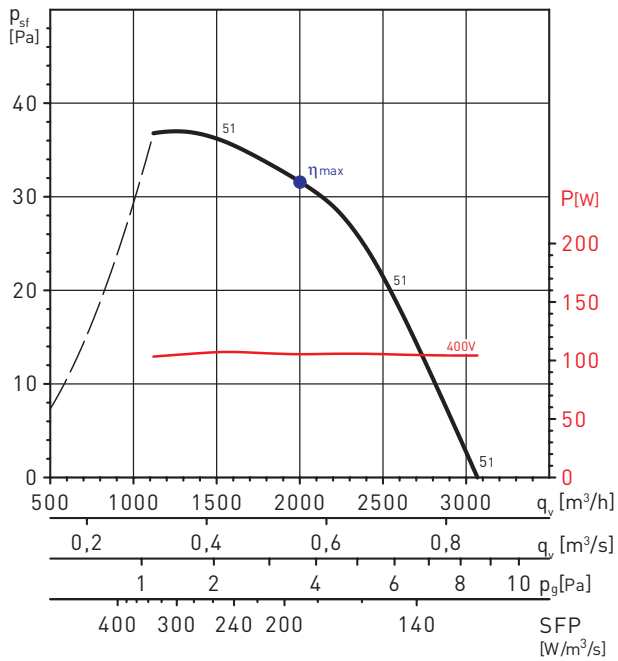

HCFT/6-450/H

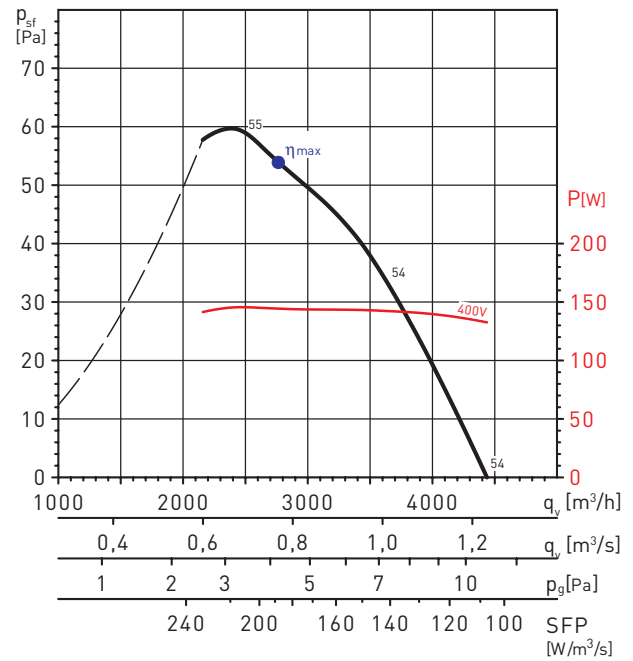

MC	EC	VSD	SR	η [%]	N	[kW]	[m³/h]	[Pa]	[RPM]
A	Static	No	1	28,8	40,4	0,144	2920	51	897

HCFT/6-500/H

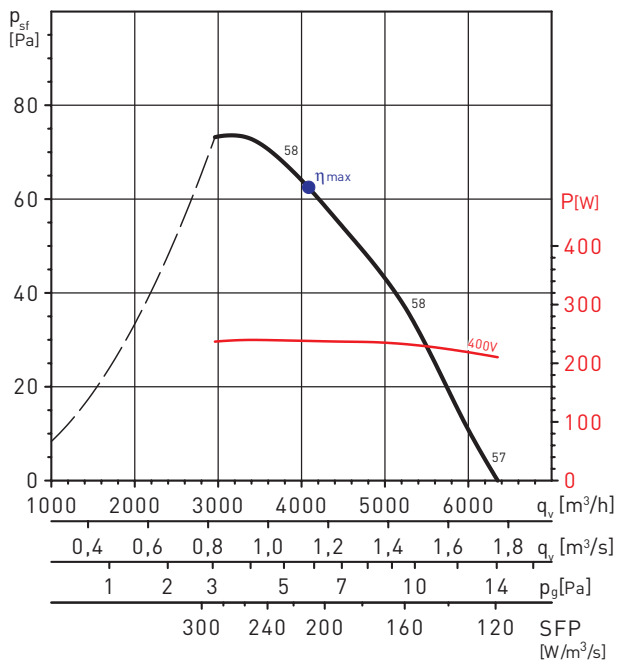

HCFT/6-560/H

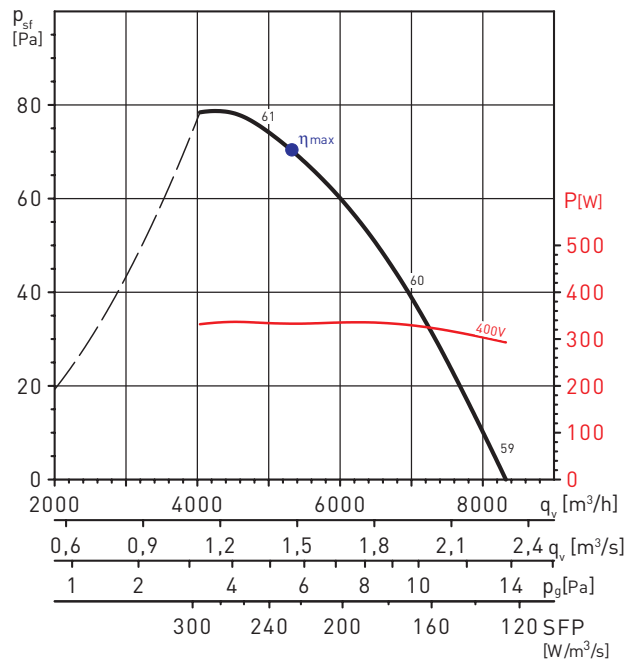

MC	EC	VSD	SR	η [%]	N	[kW]	[m³/h]	[Pa]	[RPM]
A	Static	No	1	29,9	40,2	0,239	3900	66	903

MC	EC	VSD	SR	η [%]	N	[kW]	[m³/h]	[Pa]	[RPM]
A	Static	No	1	31,2	40,5	0,333	5333	70	905

GRAFIEKEN - 6 POLEN

HCFT/6-630/H

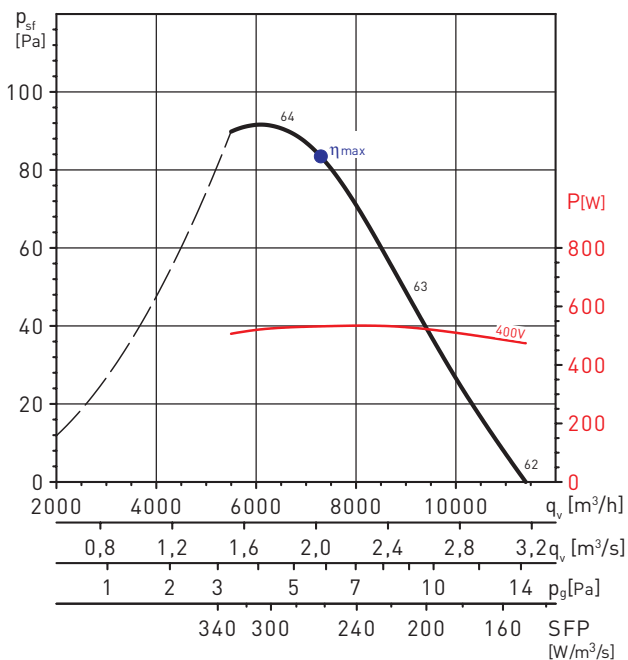

MC	EC	VSD	SR	η [%]	N	[kW]	[m³/h]	[Pa]	[RPM]
A	Static	No	1	31,9	40,0	0,531	7080	86	904

HCFT/6-710/H

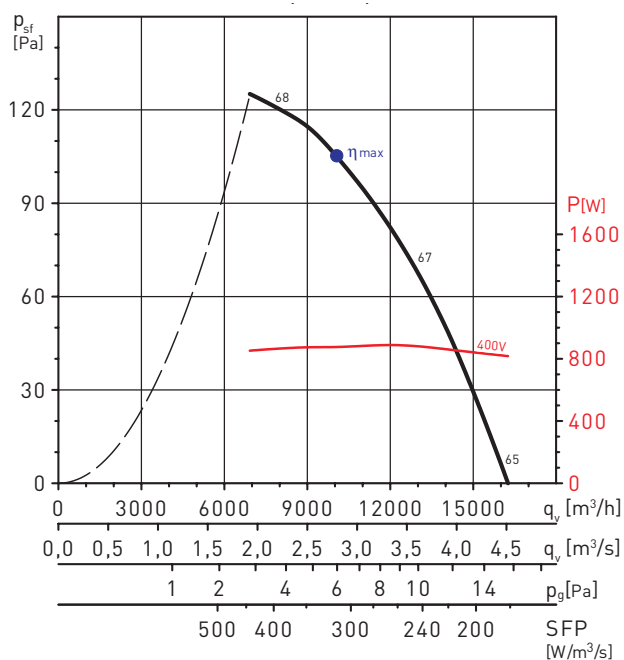

MC	EC	VSD	SR	η [%]	N	[kW]	[m³/h]	[Pa]	[RPM]
A	Static	No	1	33,5	40,2	0,876	10055	105	949

HCFT/6-800/L

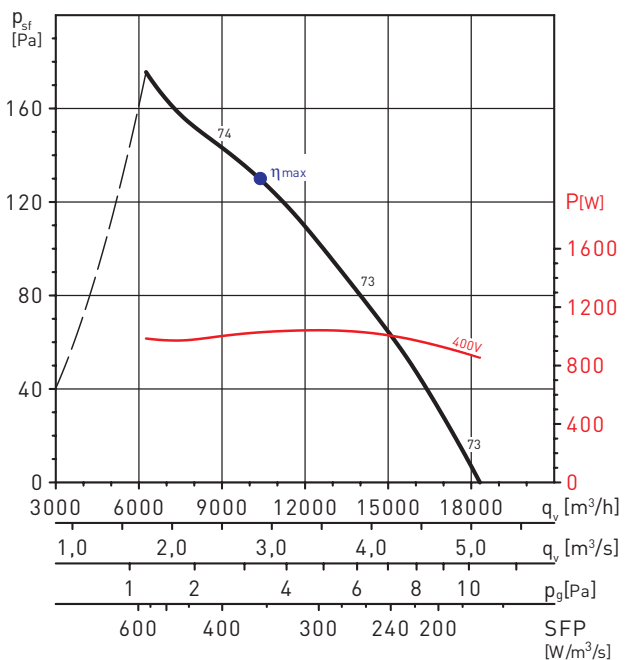

MC	EC	VSD	SR	η [%]	N	[kW]	[m³/h]	[Pa]	[RPM]
A	Static	No	1	36,4	42,7	1,028	10372	130	922

HCFT/6-800/H

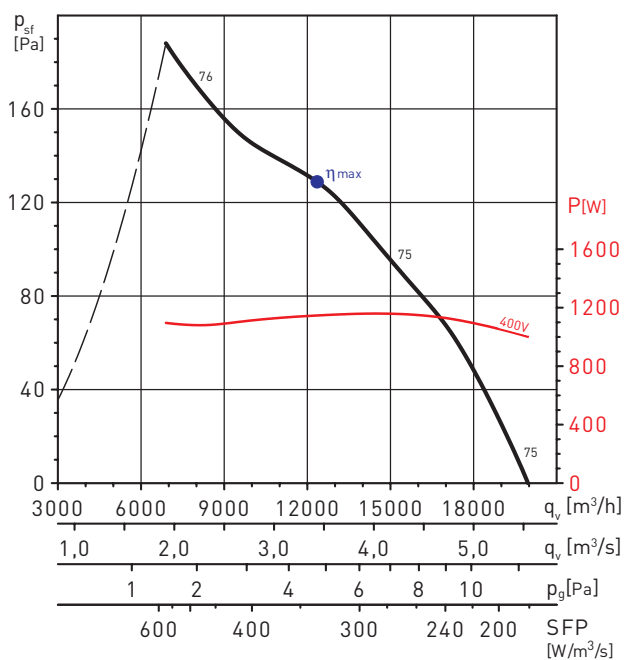

MC	EC	VSD	SR	η [%]	N	[kW]	[m³/h]	[Pa]	[RPM]
A	Static	No	1	38,7	44,7	1,147	12360	129	931

GRAFIEKEN - 6 POLEN

HCFT/6-900/L

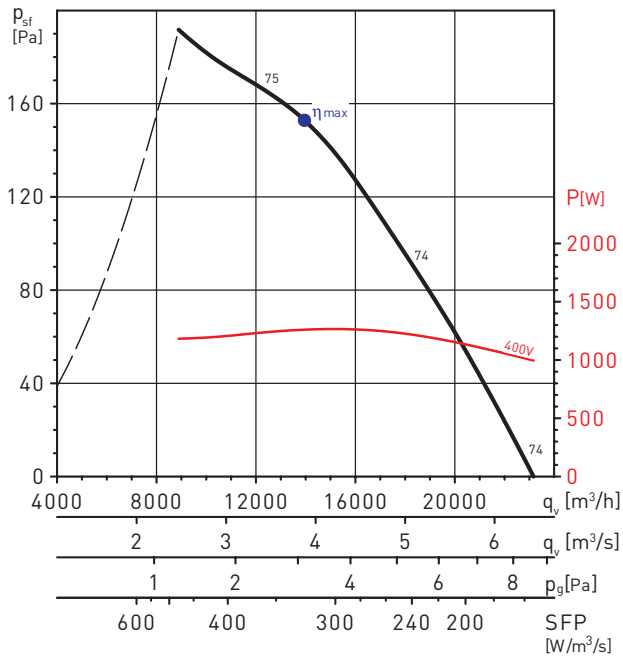

MC	EC	VSD	SR	η [%]	N	[kW]	[m ³ /h]	[Pa]	[RPM]
A	Static	No	1	47,1	52,8	1,260	13960	153	954

HCFT/6-900/H

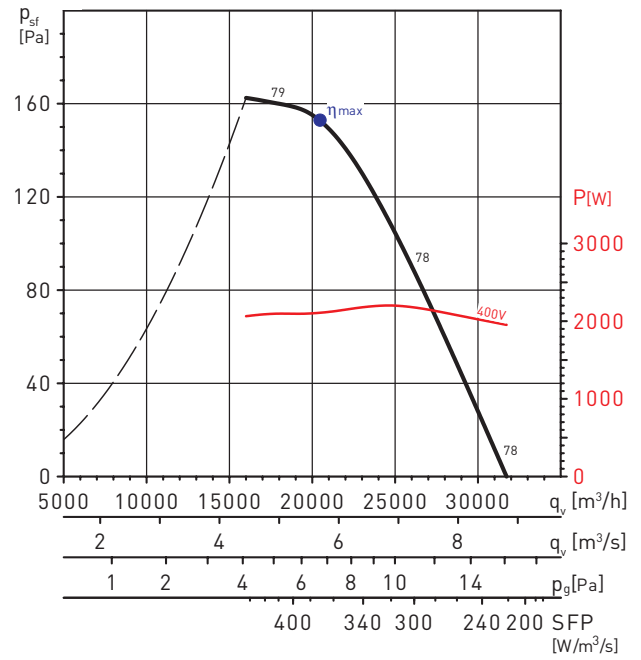

MC	EC	VSD	SR	η [%]	N	[kW]	[m ³ /h]	[Pa]	[RPM]
A	Static	No	1	41,2	45,5	2,107	20461	153	947

HCFT/6-1000/L

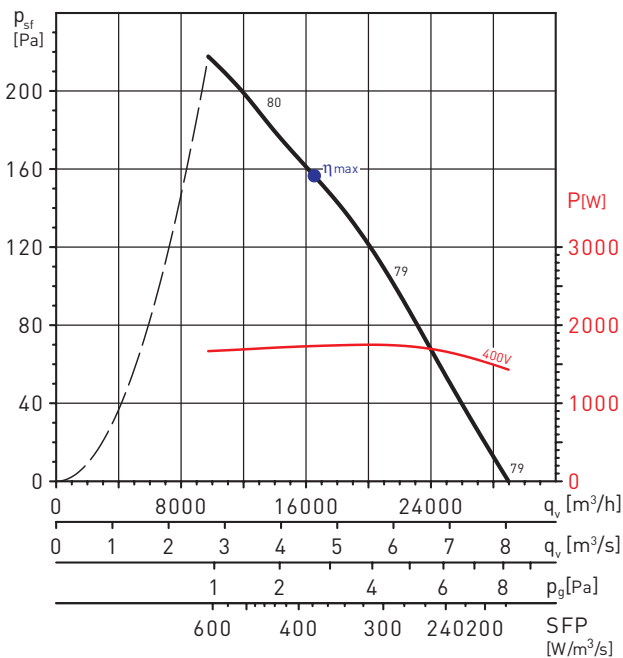

MC	EC	VSD	SR	η [%]	N	[kW]	[m ³ /h]	[Pa]	[RPM]
A	Static	No	1	41,6	46,4	1,733	16522	157	926

HCFT/6-1000/H

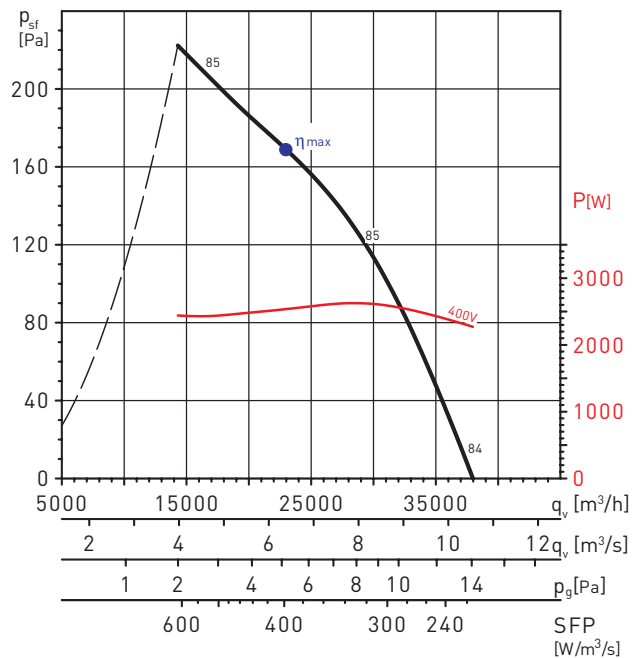

MC	EC	VSD	SR	η [%]	N	[kW]	[m ³ /h]	[Pa]	[RPM]
A	Static	No	1	42,6	46,4	2,536	22959	169	931

GRAFIEKEN - 6 POLEN

HCBB/4-250/H

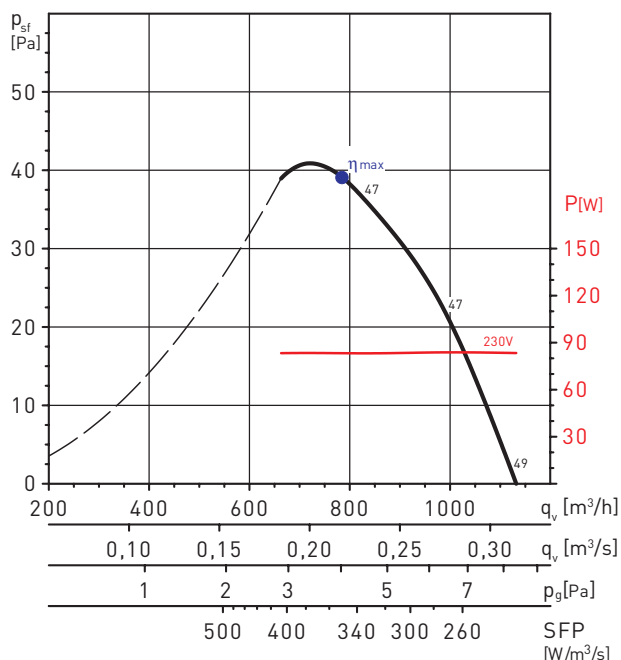

HCBB/4-315/H

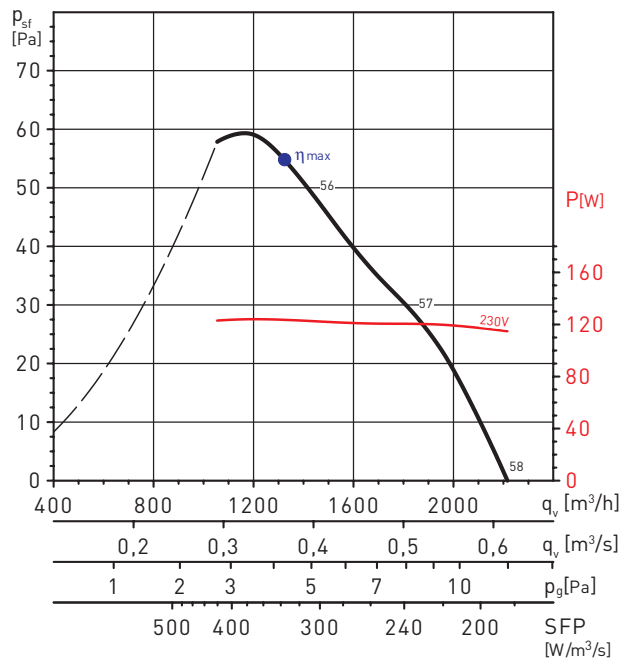

HCBB/4-355/H

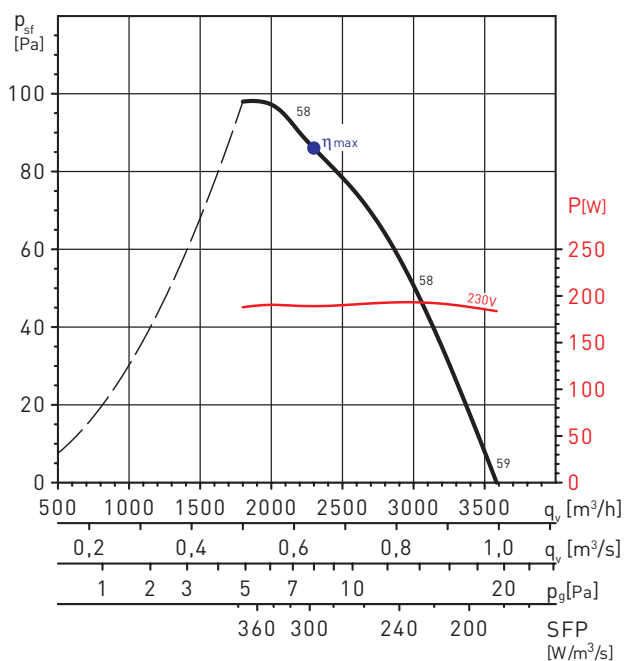

HCBB/4-400/H

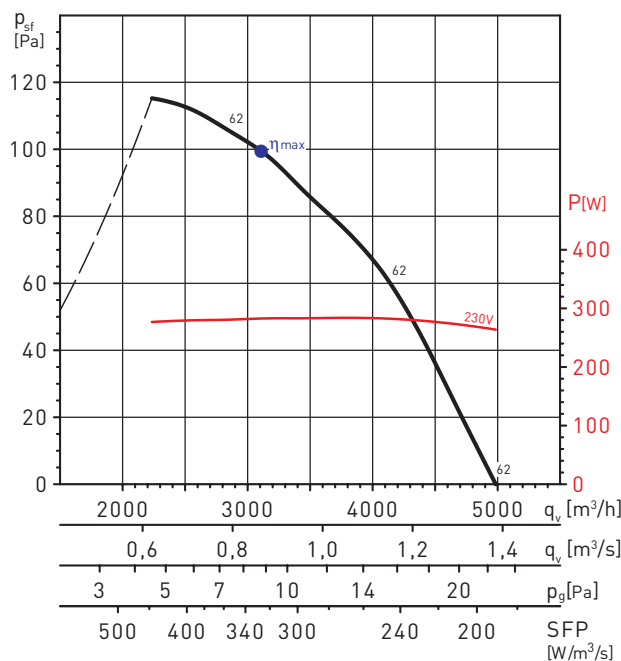

MC	EC	VSD	SR	η [%]	N	[kW]	[m³/h]	[Pa]	[RPM]
A	Static	No	1	29,1	40,0	0,189	2300	86	1377

MC	EC	VSD	SR	η [%]	N	[kW]	[m³/h]	[Pa]	[RPM]
A	Static	No	1	30,4	40,2	0,283	3107	100	1327

GRAFIEKEN - 4 POLEN

HCBB/4-450/H

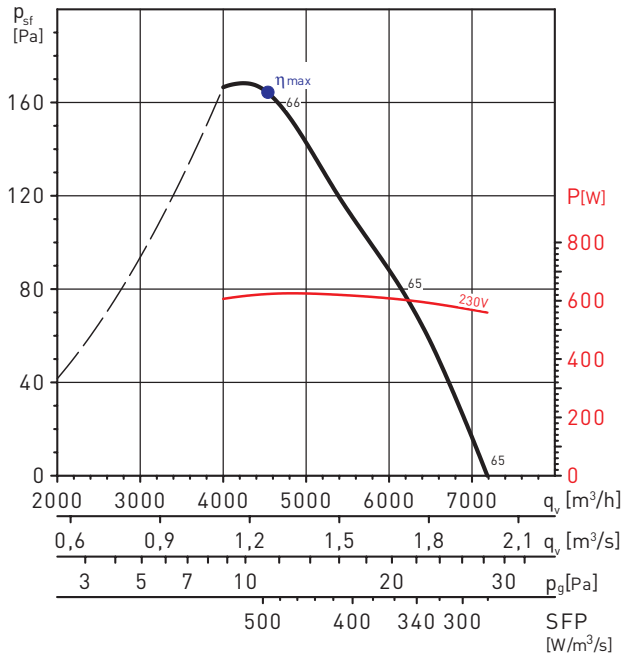

MC	EC	VSD	SR	η [%]	N	[kW]	[m ³ /h]	[Pa]	[RPM]
A	Static	No	1	33,2	40,8	0,623	4538	164	1390

HCBB/4-500/H

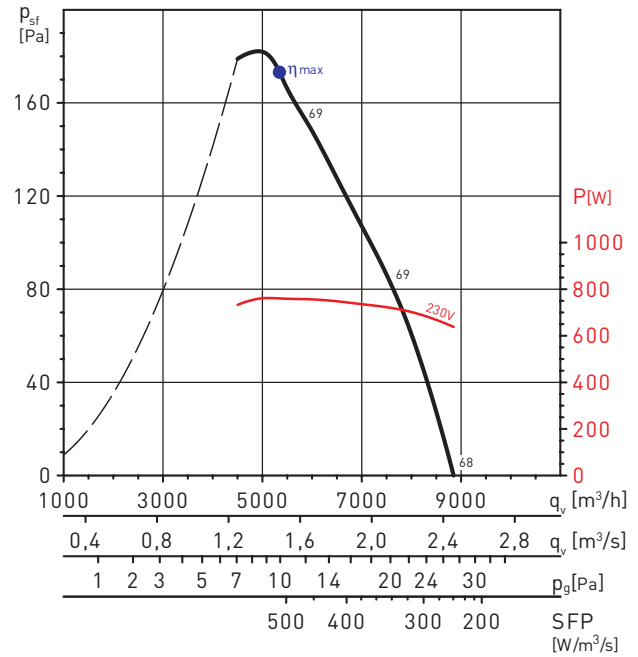

MC	EC	VSD	SR	η [%]	N	[kW]	[m ³ /h]	[Pa]	[RPM]
A	Static	No	1	33,6	40,7	0,760	5336	172	1322

HCBB/4-560/H

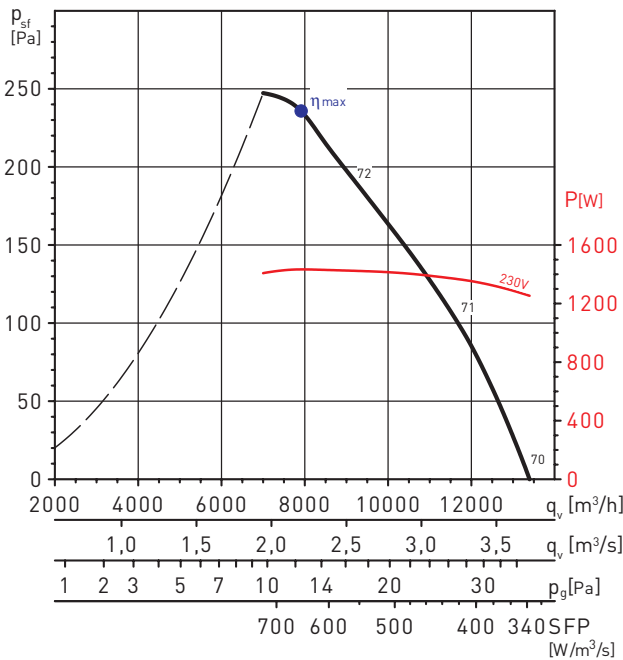

MC	EC	VSD	SR	η [%]	N	[kW]	[m ³ /h]	[Pa]	[RPM]
A	Static	No	1	36,0	41,3	1,433	7896	235	1367

HCBB/4-630/H

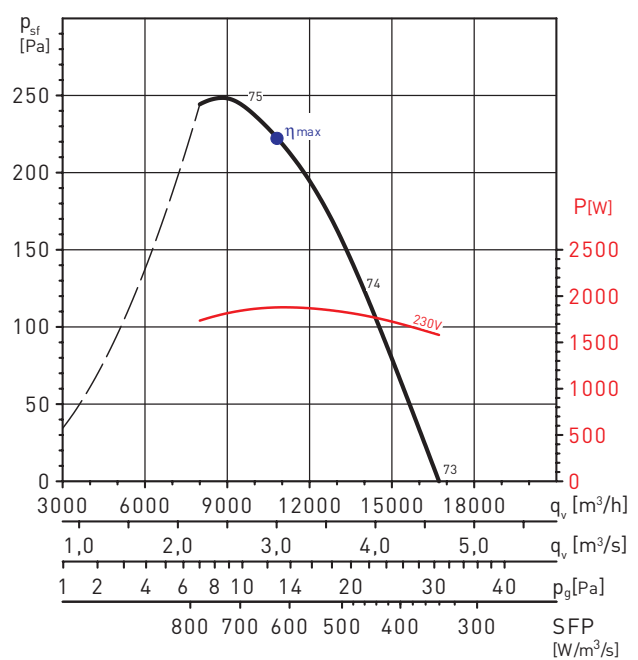

MC	EC	VSD	SR	η [%]	N	[kW]	[m ³ /h]	[Pa]	[RPM]
A	Static	No	1	35,6	40,2	1,878	10817	223	1305

GRAFIEKEN - 4 POLEN

HCBT/4-250/H

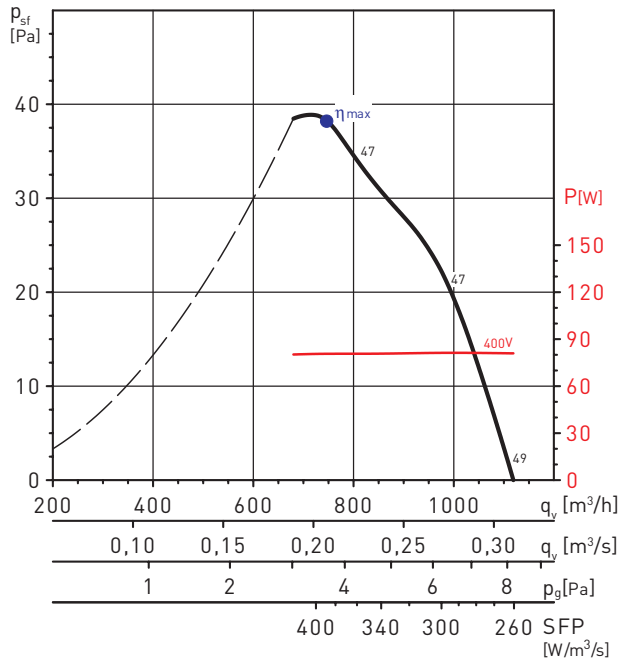

HCBT/4-315/H

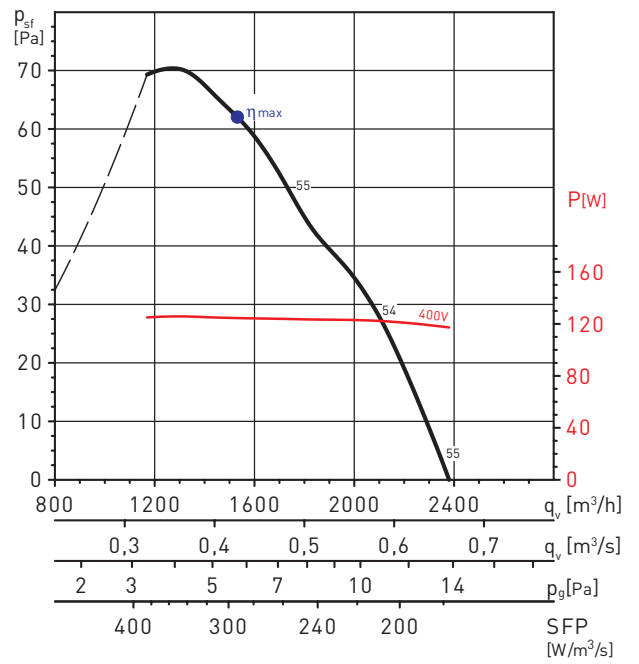

HCBT/4-355/H

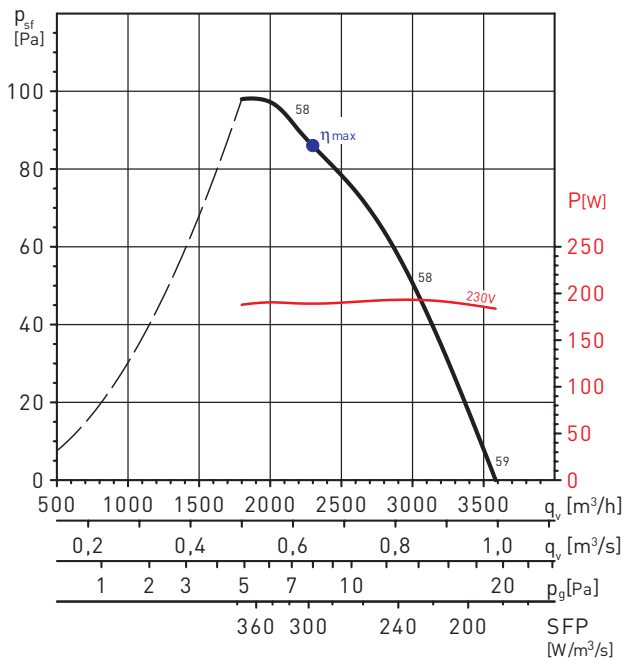

HCBT/4-400/H

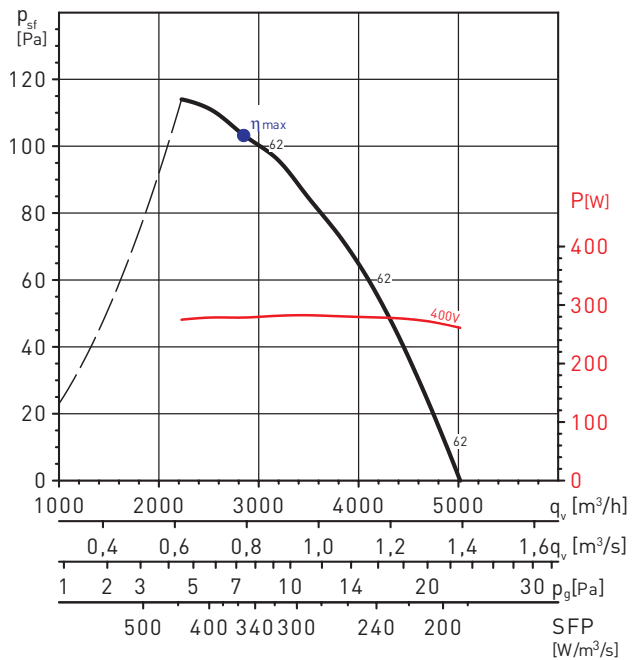

MC	EC	VSD	SR	η [%]	N	[kW]	[m³/h]	[Pa]	[RPM]
A	Static	No	1	29,0	40,0	0,179	2163	86	1372

MC	EC	VSD	SR	η [%]	N	[kW]	[m³/h]	[Pa]	[RPM]
A	Static	No	1	30,2	40,0	0,281	3127	98	1332

GRAFIEKEN - 4 POLEN

HCBT/4-450/H

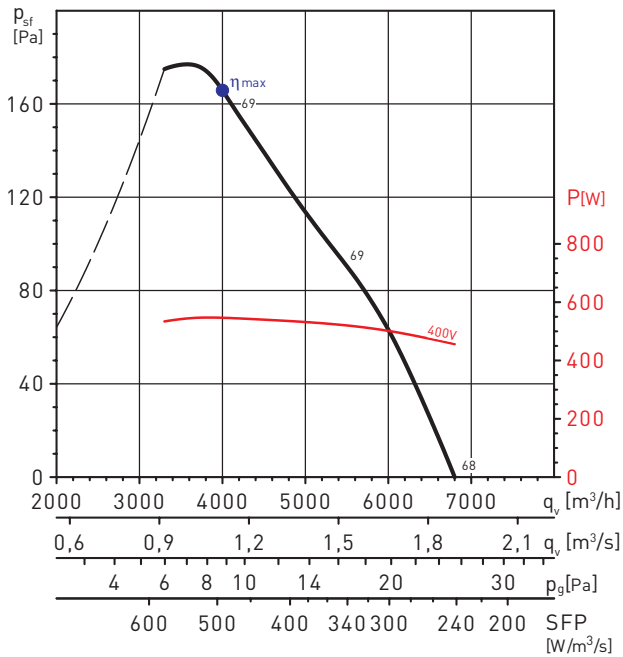

MC	EC	VSD	SR	η [%]	N	[kW]	[m³/h]	[Pa]	[RPM]
A	Static	No	1	33,6	41,3	0,605	4179	175	1391

HCBT/4-500/H

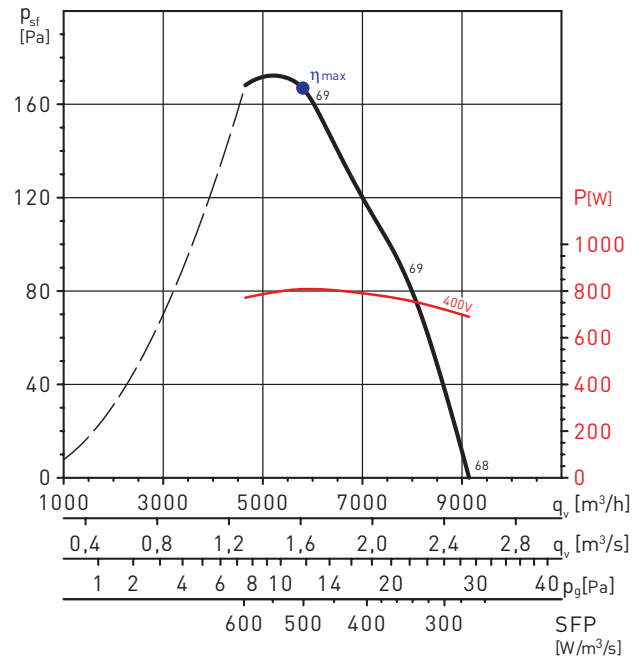

MC	EC	VSD	SR	η [%]	N	[kW]	[m³/h]	[Pa]	[RPM]
A	Static	No	1	33,1	40,0	0,808	5793	167	1357

HCBT/4-560/H

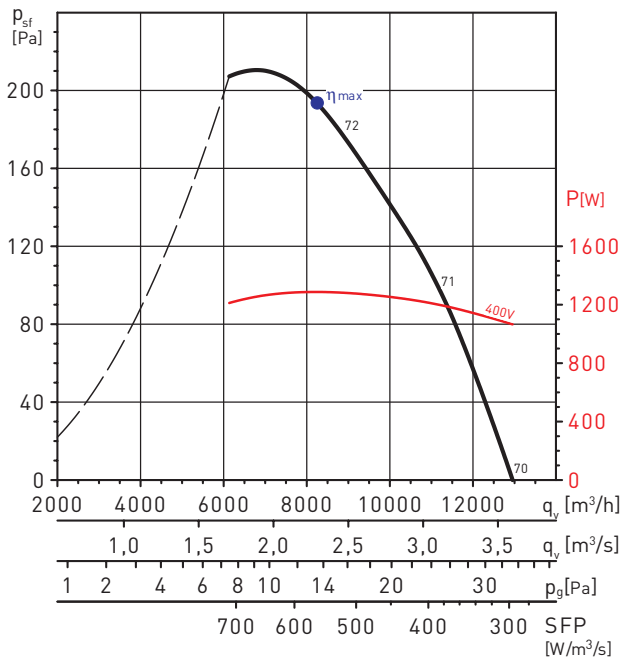

MC	EC	VSD	SR	η [%]	N	[kW]	[m³/h]	[Pa]	[RPM]
A	Static	No	1	34,4	40,0	1,287	8244	194	1349

HCBT/4-630/H

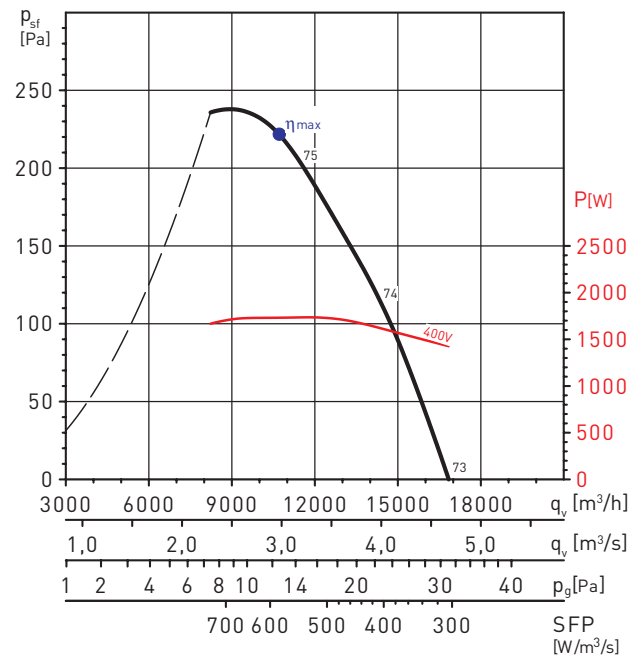

MC	EC	VSD	SR	η [%]	N	[kW]	[m³/h]	[Pa]	[RPM]
A	Static	No	1	38,1	42,9	1,731	10708	222	1355

GRAFIEKEN - 4 POLEN

HCBT/4-710/H

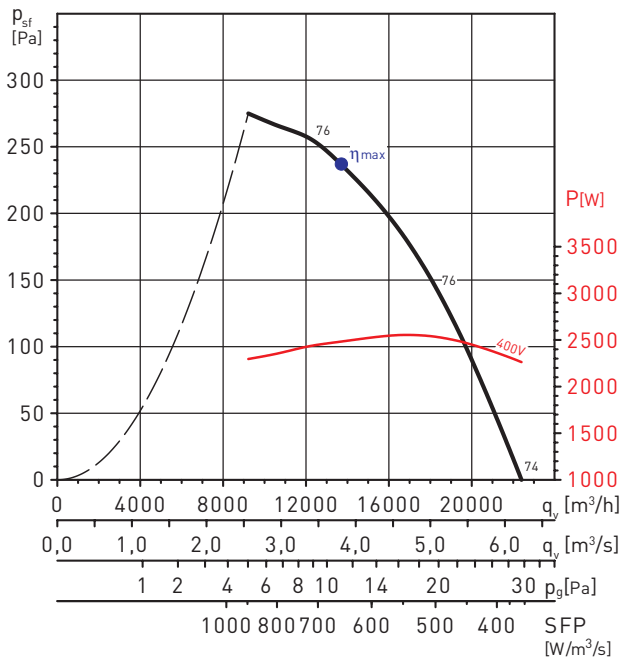

MC	EC	VSD	SR	η [%]	N	[kW]	[m ³ /h]	[Pa]	[RPM]
A	Static	No	1	36,3	40,1	2,483	13700	237	1326

HCBT/4-800/L

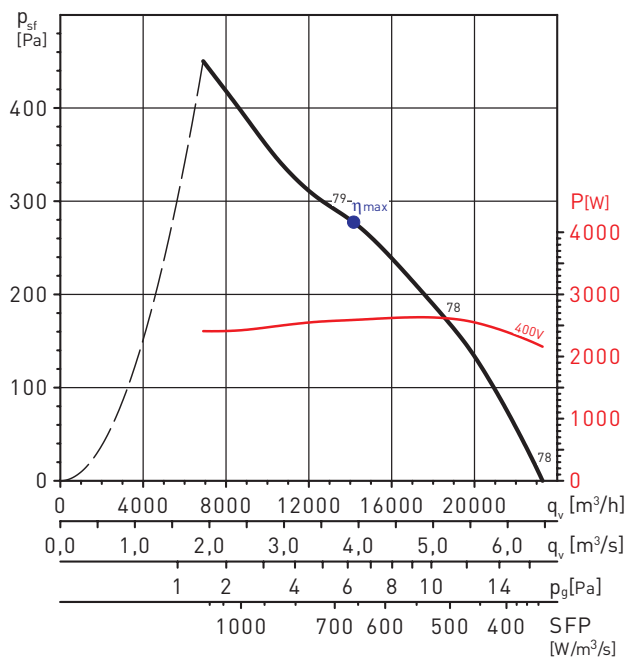

MC	EC	VSD	SR	η [%]	N	[kW]	[m ³ /h]	[Pa]	[RPM]
A	Static	No	1	42,2	45,9	2,589	14152	278	1376

HCBT/4-800/H

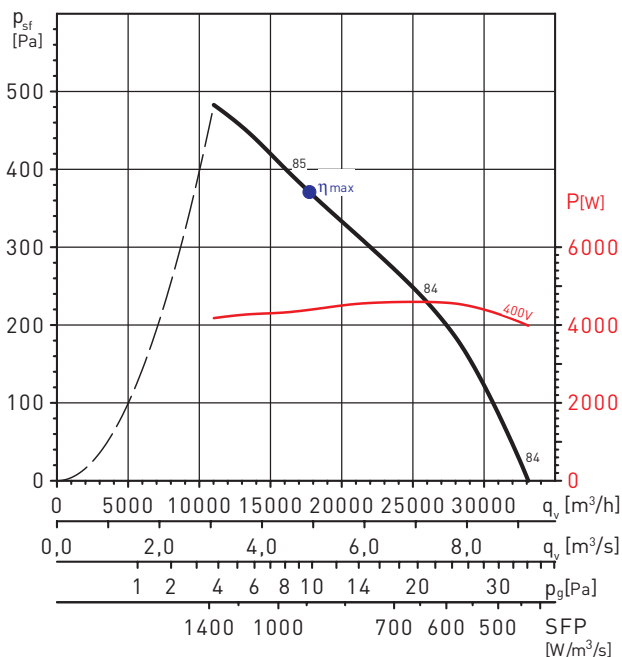

MC	EC	VSD	SR	η [%]	N	[kW]	[m ³ /h]	[Pa]	[RPM]
A	Static	No	1	41,7	44,0	4,389	17734	371	1431

HCBT/4-900/L

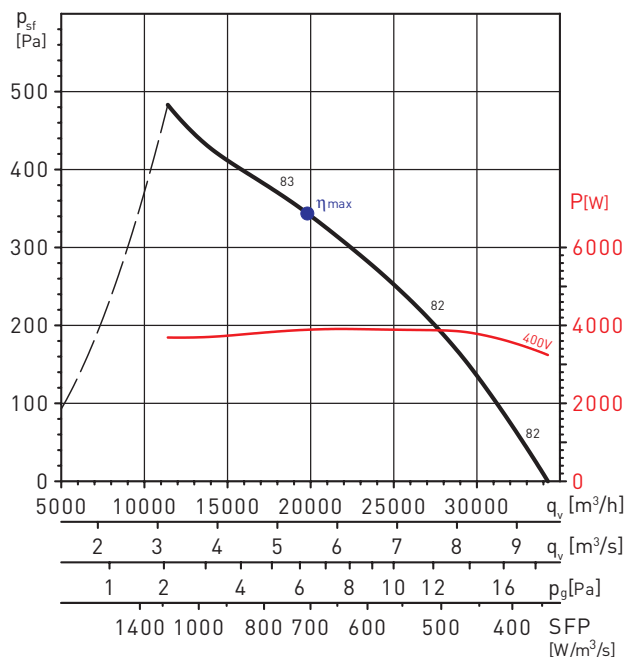

MC	EC	VSD	SR	η [%]	N	[kW]	[m ³ /h]	[Pa]	[RPM]
A	Static	No	1	48,6	51,2	3,889	19789	344	1436

GRAFIEKEN - 4 POLEN

HCBT/4-900/H

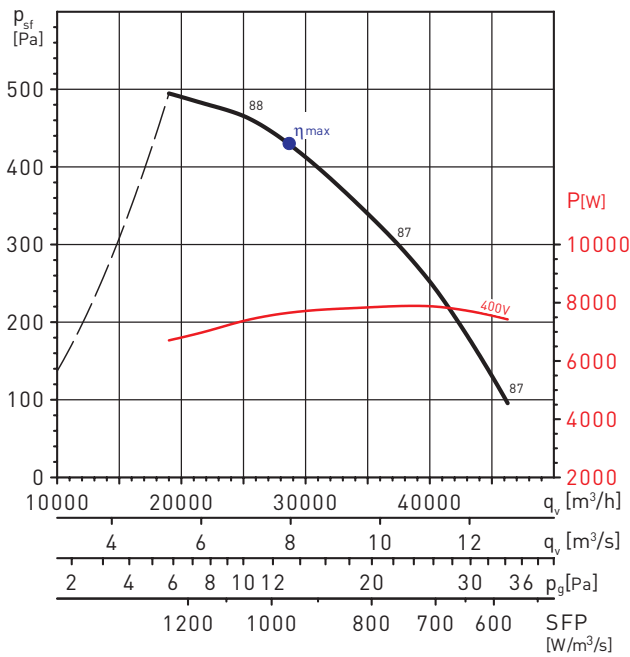

MC	EC	VSD	SR	η [%]	N	[kW]	[m^3/h]	[Pa]	[RPM]
A	Static	No	1	44,7	45,5	7,657	28654	430	1446

HCBT/4-1000/L

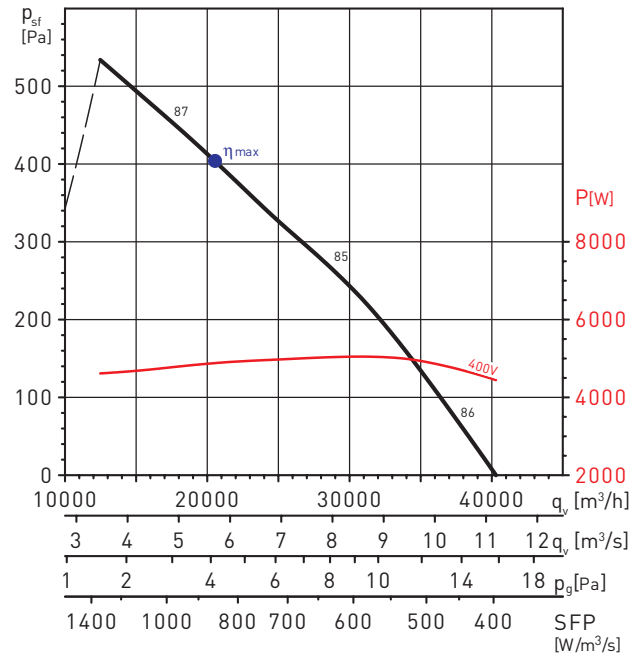

MC	EC	VSD	SR	η [%]	N	[kW]	[m^3/h]	[Pa]	[RPM]
A	Static	No	1	47,2	49,2	4,883	20544	404	1402

HCBT/4-1000/H

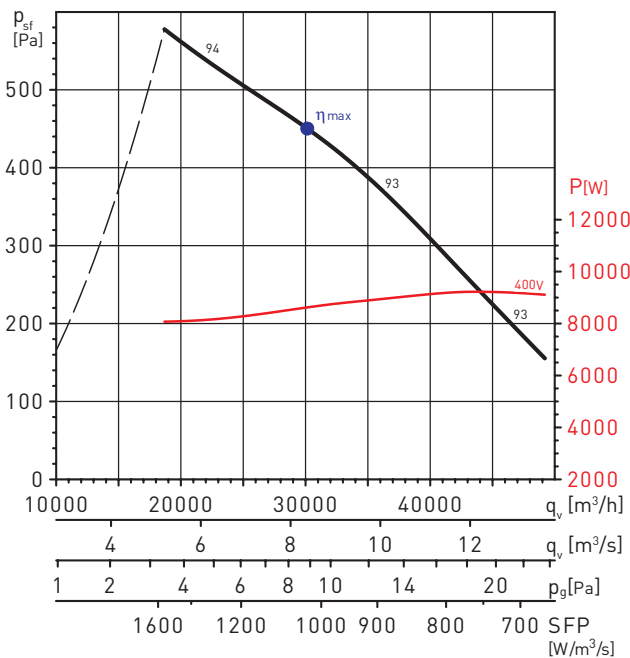

MC	EC	VSD	SR	η [%]	N	[kW]	[m^3/h]	[Pa]	[RPM]
A	Static	No	1	43,7	44,1	8,620	30113	451	1437

GRAFIEKEN - 6 POLEN

HCBB/6-355/H

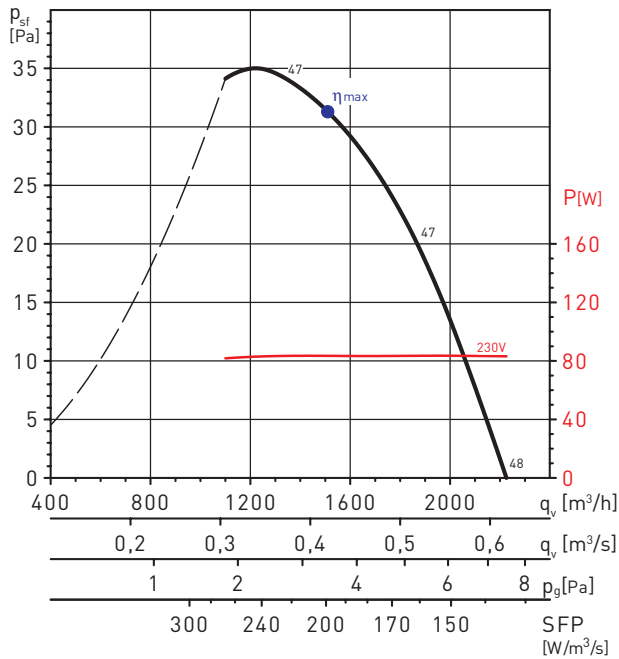

HCBB/6-400/H

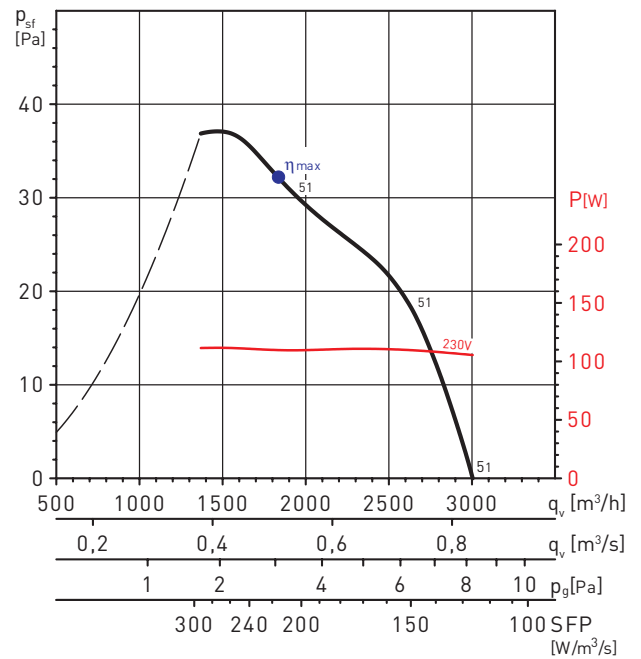

HCBB/6-450/H

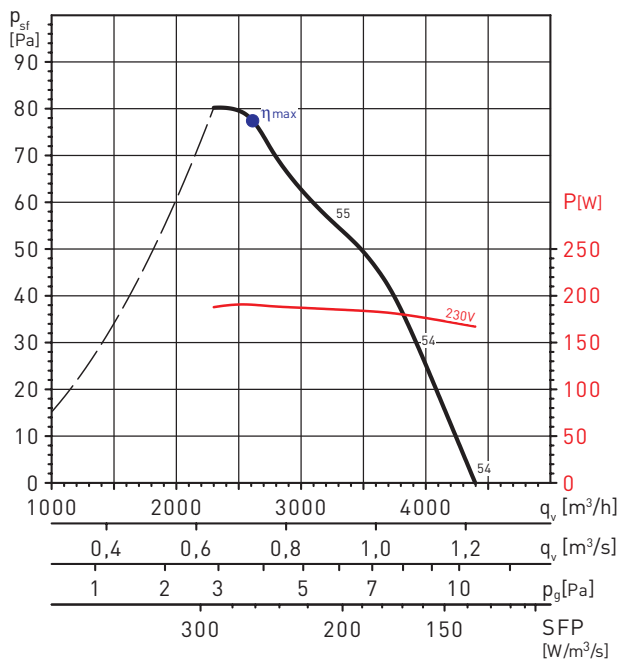

HCBB/6-500/H

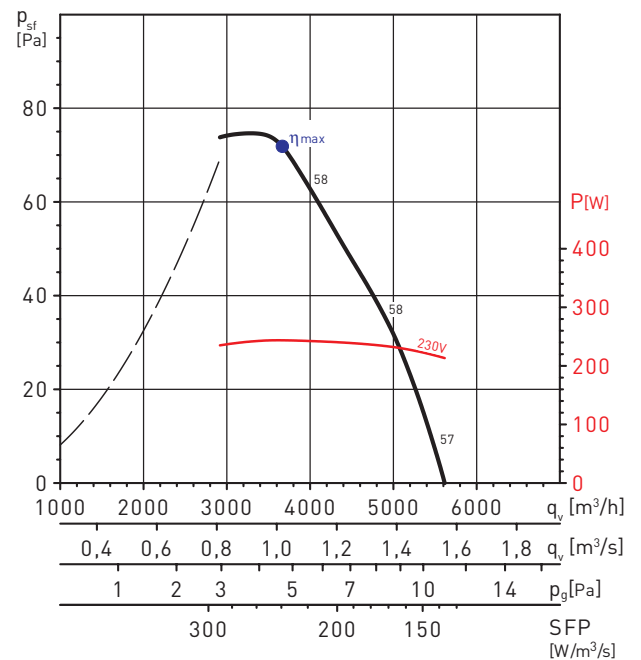

MC	EC	VSD	SR	η [%]	N	[kW]	[m³/h]	[Pa]	[RPM]
A	Static	No	1	29,3	40,2	0,190	2604	77	908

MC	EC	VSD	SR	η [%]	N	[kW]	[m³/h]	[Pa]	[RPM]
A	Static	No	1	29,9	40,1	0,244	3660	72	886

GRAFIEKEN - 6 POLEN

HCBB/6-560/H

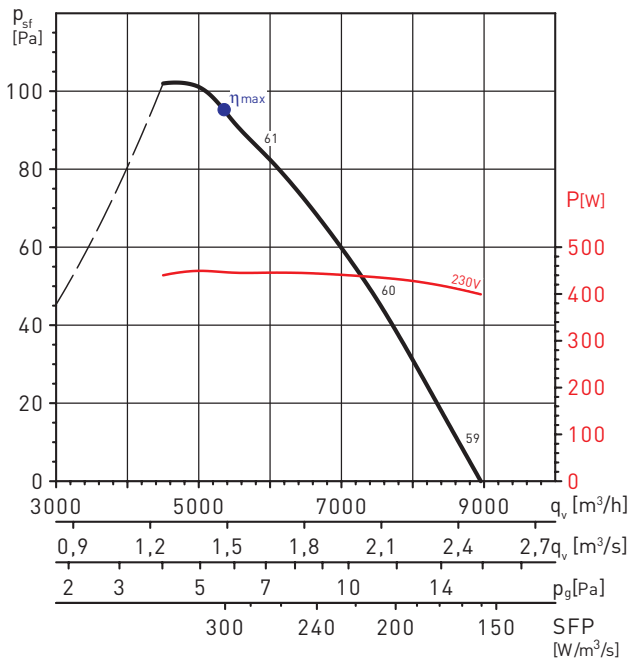

MC	EC	VSD	SR	η [%]	N	[kW]	[m³/h]	[Pa]	[RPM]
A	Static	No	1	31,6	40,1	0,447	5347	95	903

HCBB/6-630/H

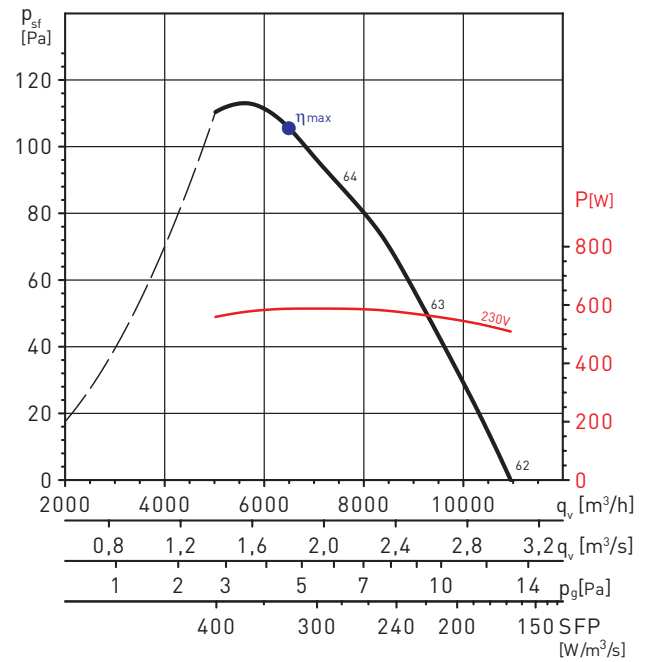

MC	EC	VSD	SR	η [%]	N	[kW]	[m³/h]	[Pa]	[RPM]
A	Static	No	1	32,4	40,2	0,587	6492	106	888

HCBT/6-355/H

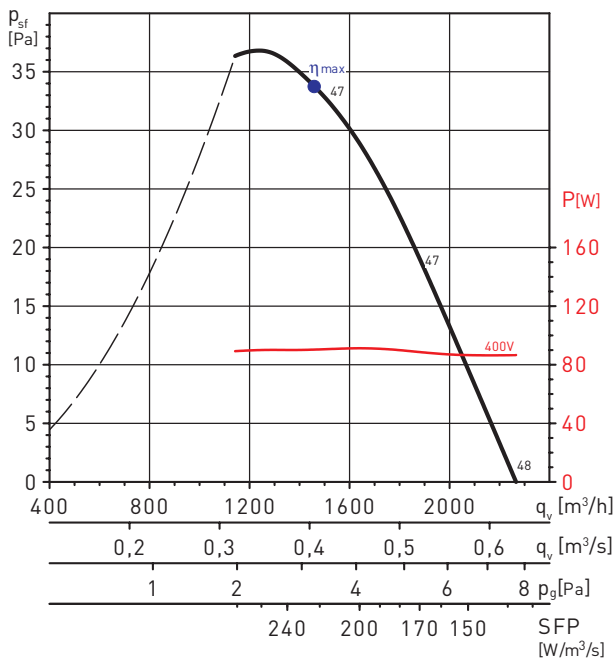

HCBT/6-400/H

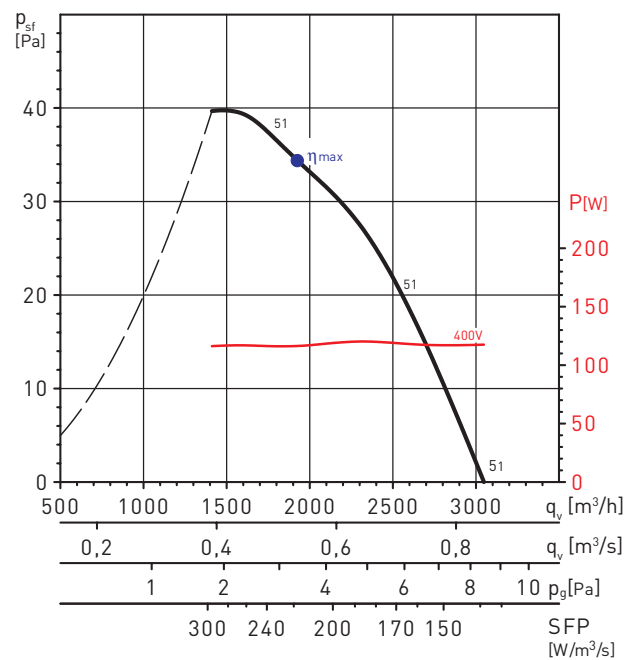

GRAFIEKEN - 6 POLEN

HCBT/6-450/H

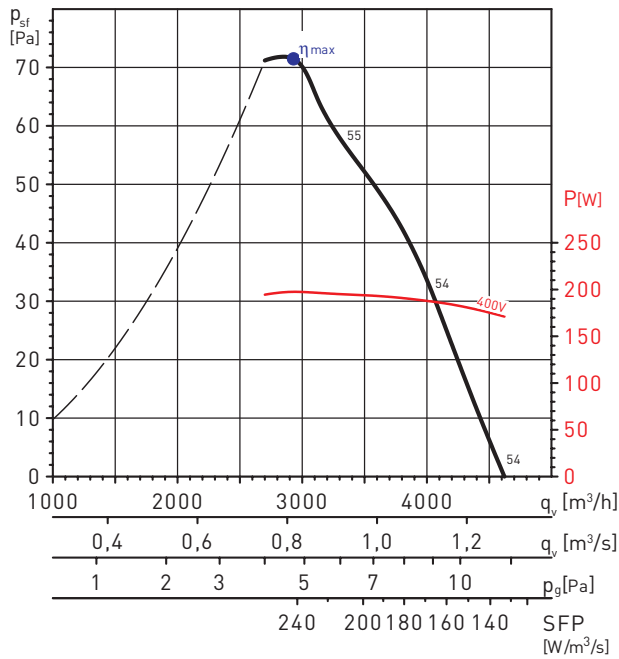

MC	EC	VSD	SR	η [%]	N	[kW]	[m³/h]	[Pa]	[RPM]
A	Static	No	1	29,3	40,1	0,198	2925	71	904

HCBT/6-500/H

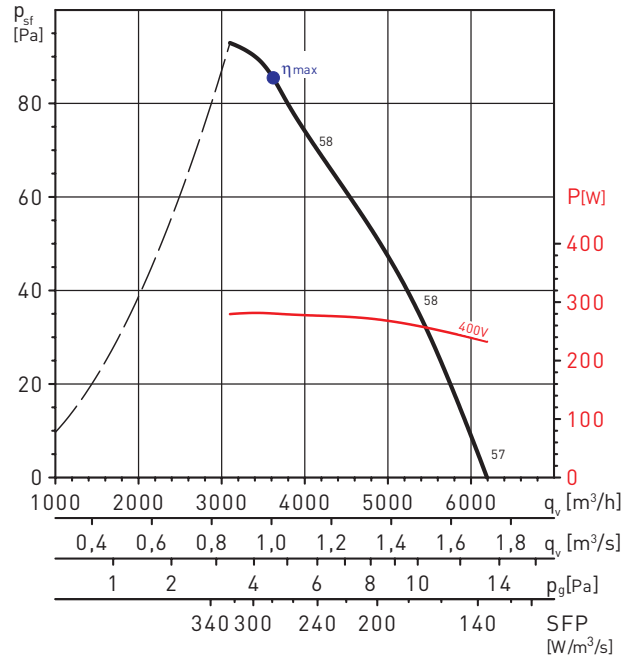

MC	EC	VSD	SR	η [%]	N	[kW]	[m³/h]	[Pa]	[RPM]
A	Static	No	1	30,3	40,1	0,281	3613	85	874

HCBT/6-560/H

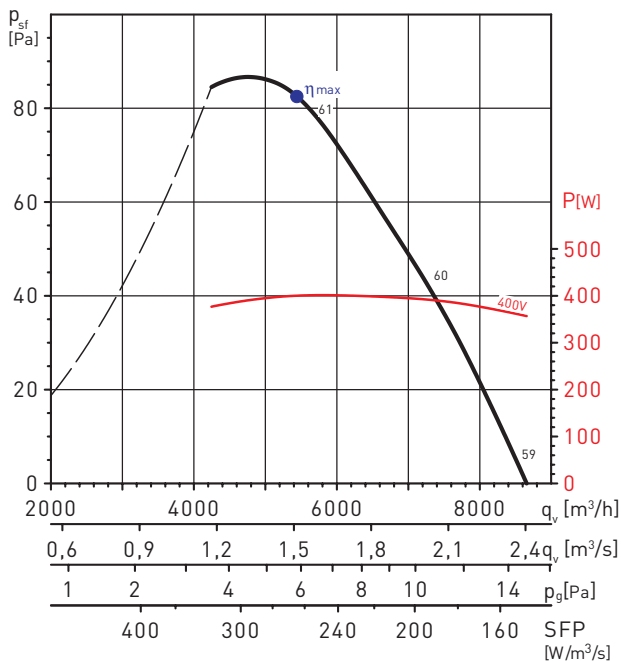

MC	EC	VSD	SR	η [%]	N	[kW]	[m³/h]	[Pa]	[RPM]
A	Static	No	1	31,2	40,0	0,400	5444	83	876

HCBT/6-630/H

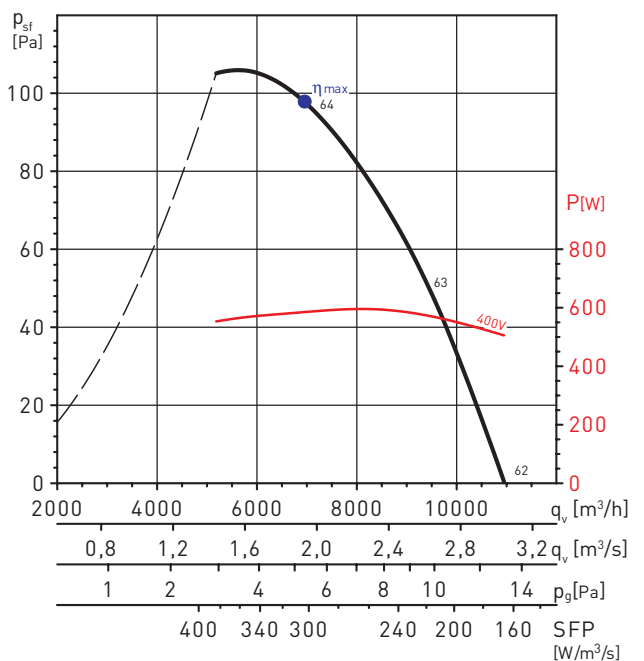

MC	EC	VSD	SR	η [%]	N	[kW]	[m³/h]	[Pa]	[RPM]
A	Static	No	1	32,3	40,1	0,585	6954	98	889

GRAFIEKEN - 6 POLEN

HCBT/6-710/H

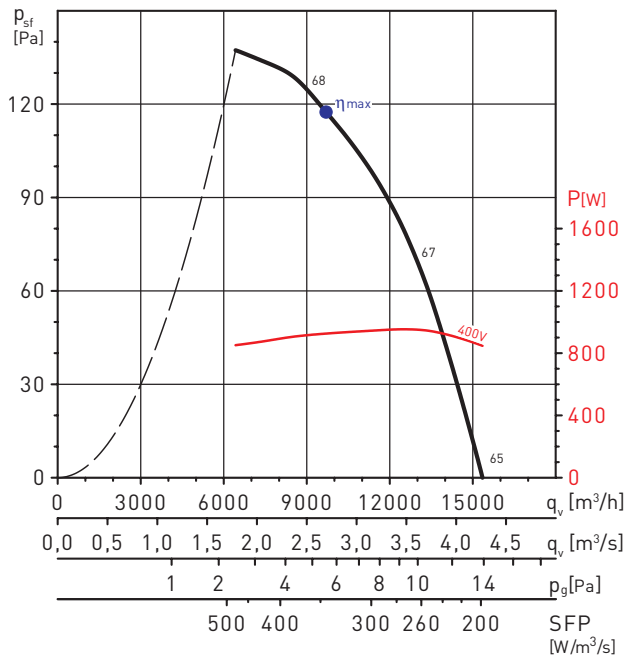

MC	EC	VSD	SR	η [%]	N	[kW]	[m³/h]	[Pa]	[RPM]
A	Static	No	1	34,2	40,7	0,926	9683	118	946

HCBT/6-800/L

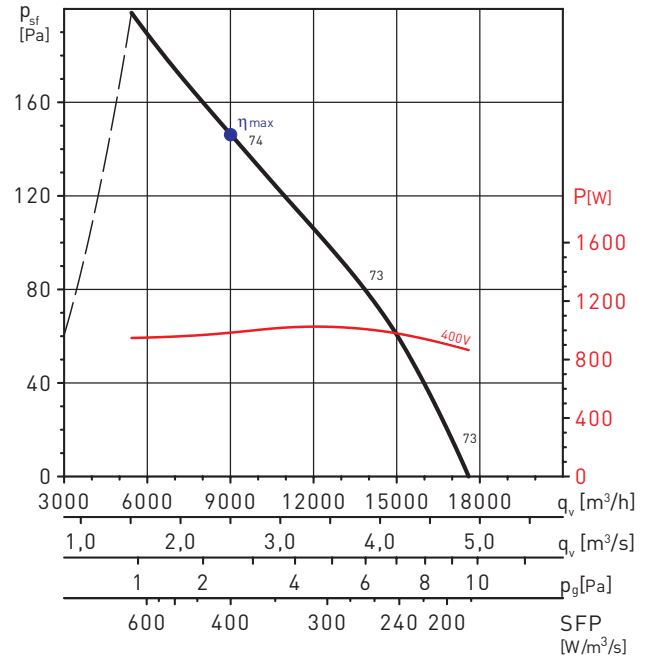

MC	EC	VSD	SR	η [%]	N	[kW]	[m³/h]	[Pa]	[RPM]
A	Static	No	1	37,2	43,6	0,984	9004	146	927

HCBT/6-800/H

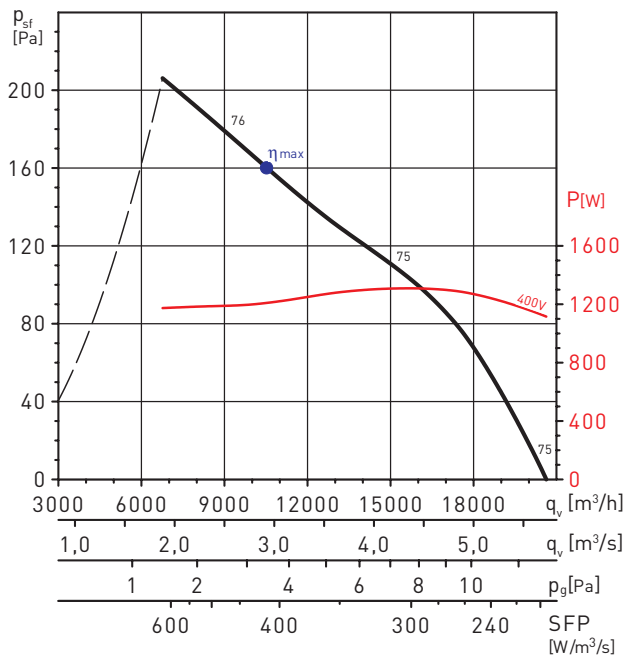

MC	EC	VSD	SR	η [%]	N	[kW]	[m³/h]	[Pa]	[RPM]
A	Static	No	1	38,8	44,6	1,208	10519	160	923

HCBT/6-900/L

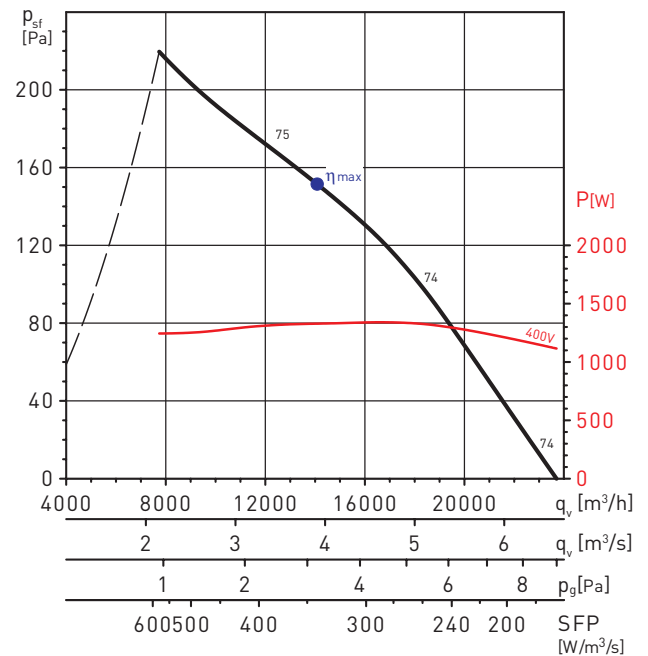

MC	EC	VSD	SR	η [%]	N	[kW]	[m³/h]	[Pa]	[RPM]
A	Static	No	1	44,6	50,2	1,329	14066	152	953

GRAFIEKEN - 6 POLEN

HCBT/6-900/H

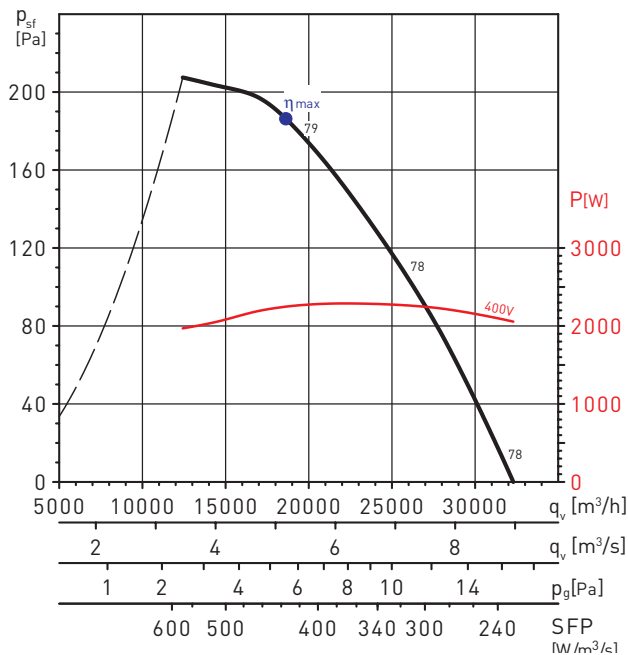

MC	EC	VSD	SR	η [%]	N	[kW]	[m³/h]	[Pa]	[RPM]
A	Static	No	1	42,8	46,9	2,247	18590	187	943

HCBT/6-1000/L

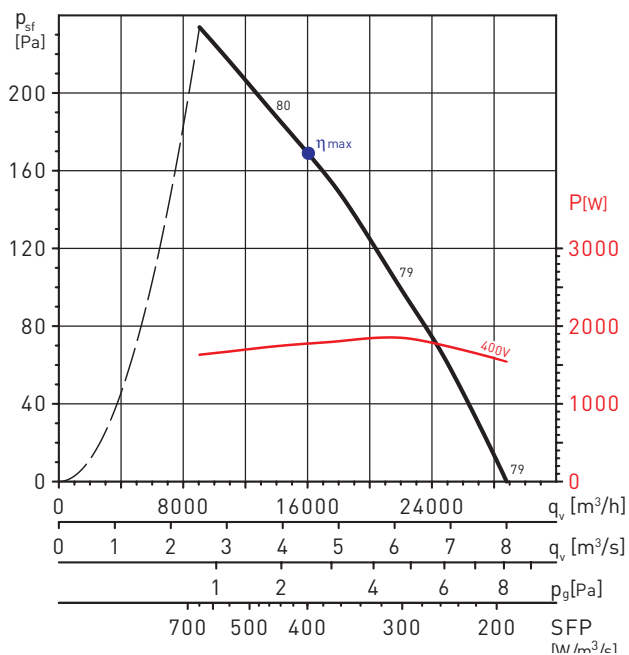

MC	EC	VSD	SR	η [%]	N	[kW]	[m³/h]	[Pa]	[RPM]
A	Static	No	1	42,4	47,2	1,775	16021	169	927

HCBT/6-1000/H

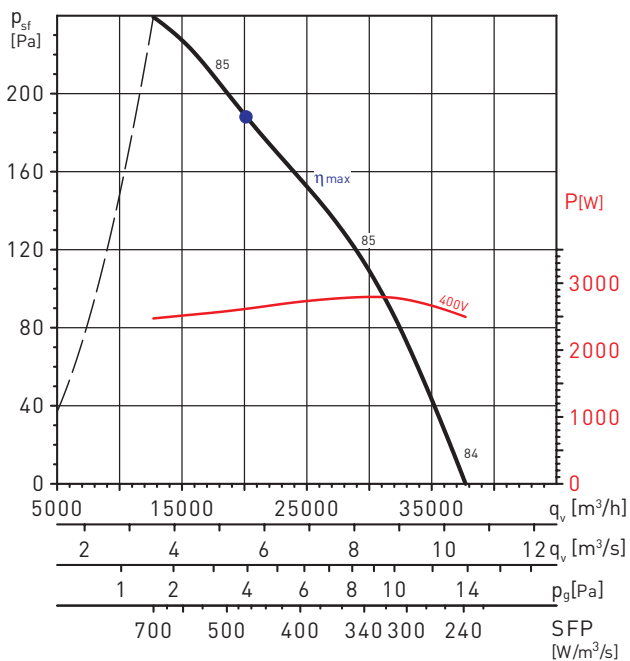

MC	EC	VSD	SR	η [%]	N	[kW]	[m³/h]	[Pa]	[RPM]
A	Static	No	1	40,3	44,0	2,615	20140	188	929