



Enkelaanzuigend



Serie enkel- en dubbelaanzuigende centrifugale lagedruk ventilatoren met directe aandrijving, vervaardigd uit verzinkt plaatstaal en tegen corrosie beschermd met een zwarte polyester coating. Alle modellen hebben centrifugale waaiers met voorover gebogen schoepen van verzinkt plaatstaal. Leverbaar met 1- of 3-fasige motoren met 2, 4 of 6 polen.

Motoren

Alle motoren zijn IP44, isolatieklasse B, voorzien van thermische beveiliging en zelfsmerende kogellagers.

Spanning:

1-fasig 230 V - 50 Hz

Buitenloop motor.

Toerenregeling door transformator.

Op aanvraag:

Aansluitflens op uitblaasopening.



Dubbelaanzuigend



Compact ontwerp



Dynamisch uitgebalanceerde waaier.

TECHNISCHE GEGEVENS

Controleer vóór het tot stand brengen van een elektrische aansluiting of de spanning en de frequentie van het lichtnet overeenkomen met de technische gegevens op het typeplaatje.

Model	Maximaal opgenomen vermogen (W)	Toerental gemiddeld (rpm)	Condensator (µF/V)	Maximale opgen. stroom (A)	Maximale capaciteit (m³/h)	Werktemperatuur (°C)	Geluidsdruk-niveau* (dB(A))	Gewicht (kg)	Toeren regelaar	
									REB	SPTM
2 POLIG ENKELAANZUIGEND										
CBM/2-133/046-90W	90	2100	2/400	0,4	260	-40/+60	57	2	1	SPTM 2-1,5
CBM/2-133/062-100W	100	2000	2/400	0,4	290	-40/+40	54	2,2	1	SPTM 2-1,5
CBM/2-140/059-100W	100	1450	2/400	0,5	350	-40/+40	49	2	1	SPTM 2-1,5
CBM/2-140/059-155W	155	2300	5/400	0,7	450	-40/+45	60	2,8	1	SPTM 2-1,5
CBM/2-160/062-280W	280	2200	5/400	1,2	660	-20/+45	64	3,6	2,5	SPTM 2-1,5
4 POLIG ENKELAANZUIGEND										
CBM/4-160/062-70W	70	1340	2,5/400	0,3	450	-20/+70	54	3,6	1	SPTM 2-1,5
CBM/4-180/075-115W	115	1250	3/400	0,6	650	-20/+60	56	4,3	1	SPTM 2-1,5
CBM/4-180/092-160W	160	1275	4/400	0,9	980	-40/+50	56	3,8	1	SPTM 2-1,5
2 POLIG DUBBELAANZUIGEND										
CBM/2-133/190-185W	185	1850	5/400	0,8	630	-40/+50	56	4,1	1	SPTM 2-1,5
CBM/2-146/180-380W	380	2000	8/450	1,7	1.090	-40/+40	58	5	2,5	SPTM 2-3,5
4 POLIG DUBBELAANZUIGEND										
CBM/4-133/190-70W	70	1150	2/400	0,3	730	-20/+65	47	2,8	1	SPTM 2-1,5
CBM/4-160/150-125W	125	1150	3/400	0,5	790	-40/+40	53	5,4	1	SPTM 2-1,5
CBM/4-180/184-150W	150	1200	4/450	1,0	1.320	-40/+40	59	5,5	2,5	SPTM 2-1,5
6 POLIG DUBBELAANZUIGEND										
CBM/6-180/184-95W	95	800	2/400	0,5	960	-40/+60	50	5,3	1	SPTM 2-1,5

* Geluidsdruk in dB(A) bij de aanzuig, in het vrije veld, op 1,5 meter.

AKOESTISCHE KENMERKEN

In de volgende tabel ziet u het spectrum, geluid vermogen (LwA) bij de inblaas zijde van de ventilator, gemeten op de drie werkpunten van de ventilator in de grafiek. (PB: lage druk - PM: medium druk - PA: hoge druk).

Model		63	125	250	500	1000	2000	4000	8000	LwA
CBM/2-133/046 - 90W	PB	30	42	61	63	67	65	63	61	72
	PM	32	41	61	64	66	66	62	60	72
	PA	34	45	65	66	66	62	58	54	71
CBM/2-133/062 - 100W	PB	29	38	57	63	64	60	60	57	69
	PM	27	39	61	62	64	61	60	57	69
	PA	37	39	59	63	63	59	57	52	68
CBM/2-140/059 - 100W	PB	30	40	56	56	57	54	55	53	63
	PM	29	39	56	55	56	54	55	53	63
	PA	33	39	56	55	55	53	54	50	62
CBM/2-140/059 - 155W	PB	36	48	69	67	66	65	65	65	74
	PM	36	47	67	65	64	64	64	63	72
	PA	35	49	65	63	62	62	62	61	71
CBM/2-160/062 - 280W	PB	38	49	70	71	73	71	69	67	78
	PM	36	47	69	70	71	72	68	66	78
	PA	35	43	65	66	68	69	65	64	74
CBM/2-133/190 - 185W	PB	47	52	55	63	66	63	60	58	70
	PM	43	48	54	62	66	63	60	58	70
	PA	48	55	58	65	64	63	59	54	70
CBM/2-146/180 - 380W	PB	41	51	59	63	68	67	65	62	73
	PM	43	53	61	64	68	66	64	61	73
	PA	52	60	65	66	68	66	64	61	73
CBM/4-160/062 - 70W	PB	33	54	63	59	64	57	57	55	68
	PM	34	57	62	58	60	55	54	51	66
	PA	34	58	60	56	56	51	49	44	64
CBM/4-180/075 - 115W	PB	36	56	59	61	65	63	63	62	70
	PM	34	58	58	61	64	61	61	58	69
	PA	34	57	60	64	64	60	59	56	69
CBM/4-180/092 - 160W	PB	36	57	60	61	65	63	64	61	71
	PM	34	54	59	59	63	62	62	59	69
	PA	32	52	57	58	61	59	60	56	67
CBM/4-133/190 - 70W	PB	31	40	47	55	58	53	50	45	61
	PM	35	41	47	50	53	48	43	35	57
	PA	39	45	50	52	53	49	43	36	58
CBM/4-160/165 - 125W	PB	42	48	55	58	64	61	59	55	68
	PM	36	43	54	55	61	57	54	50	64
	PA	41	47	54	54	58	53	49	40	62
CBM/4-180/184 - 150W	PB	48	57	62	67	69	65	65	61	74
	PM	37	52	60	58	63	59	59	54	68
	PA	41	55	61	56	60	56	53	47	66
CBM/6-180/184 - 95W	PB	41	47	51	57	61	57	54	49	64
	PM	33	45	49	52	55	52	47	39	59
	PA	39	49	52	51	52	49	40	30	58

AFMETINGEN (mm)

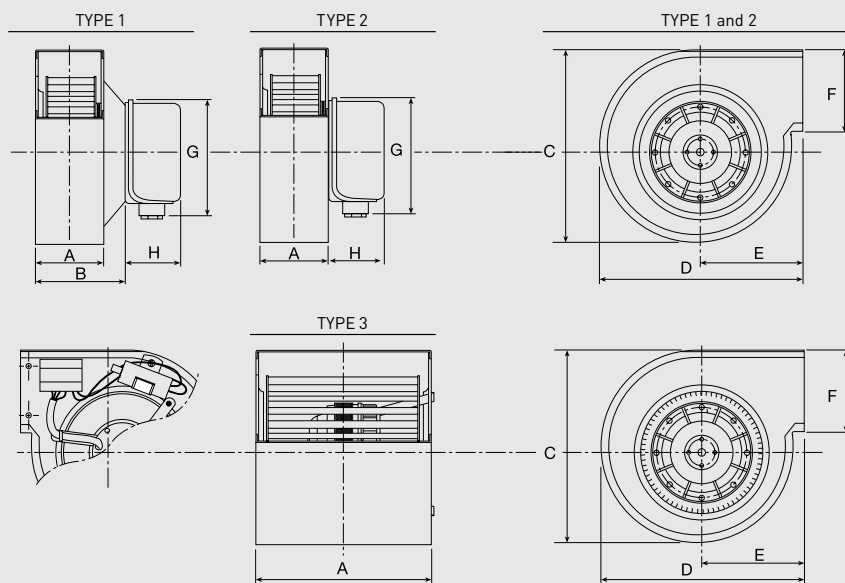

Model	Sketch	A	B	C	D	E	F	G	H
CBM/2-133/046	TYPE 1	63	80	182	175	88	69	100	46
CBM/2-133/062	TYPE 1	78	99	182	175	88	69	100	46
CBM/2-140/059	TYPE 2	98	-	244	224	103	94	100	46
CBM/2-160/062	TYPE 2	98	-	244	224	103	94	100	46
CBM/4-160/062	TYPE 2	98	-	244	224	103	94	100	46
CBM/4-180/075	TYPE 2	110	-	261	268	145	122	100	46
CBM/4-180/092	TYPE 2	136	-	332	296	133	136	100	46
CBM/2-133/190	TYPE 3	215	-	181	178	90	69	-	30*
CBM/2-146/180	TYPE 3	224	-	217	203	95	102	-	30*
CBM/4-133/190	TYPE 3	233	-	212	203	97	102	-	30*
CBM/4-160/150	TYPE 3	175	-	242	225	114	104	-	30*
CBM/4-180/184	TYPE 3	224	-	260	270	143	123	-	30*
CBM/6-180/184	TYPE 3	224	-	260	270	143	123	-	30*

* Dikte aansluitdoos en condensator aan de zijkant.

GRAFIEKEN

- q_v : Luchtvolume in m^3/h .
- p_{sf} : Statische druk in Pa.
- SFP: Specifiek vermogen $W/m^3/s$.
- I: Absorbed power A.
- LW: Sound power levels, at inlet, in dB(A).
- Meet categorie: B
- Efficiency categorie: Totaal.
- Fan efficiency zonder VSD.
- Luchtstroom data in overeenstemming met ISO 5801.

- MC** Maatvoering categorie
EC Rendements categorie
VSD Snelheidsregeling: geleverd bij de ventilator
SR Specifieke ratio
 η [%] Totaal rendement
N Rendement
[kW] Opgenomen vermogen
[m^3/h] Lucht volume
[Pa] Statische druk
[RPM] Snelheid

VOORBEELD CURVE

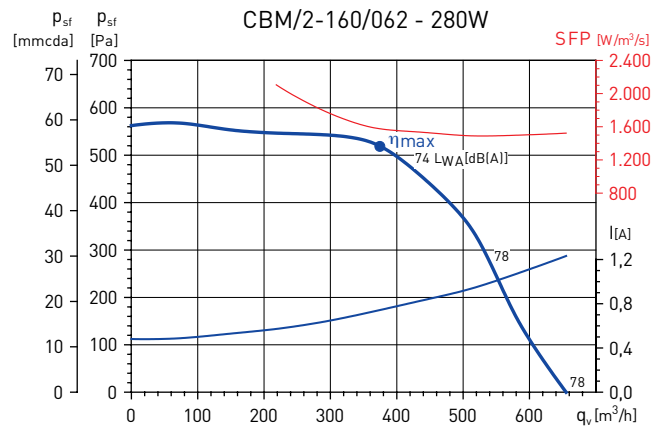

MC*	EC*	VSD*	SR*	η [%]*	N*	[kW]	[m^3/h]	[Pa]	[RPM]
B	Total	No	1,006	37,7	49,0	0,164	374	596	2647

* Ver curva ejemplo.

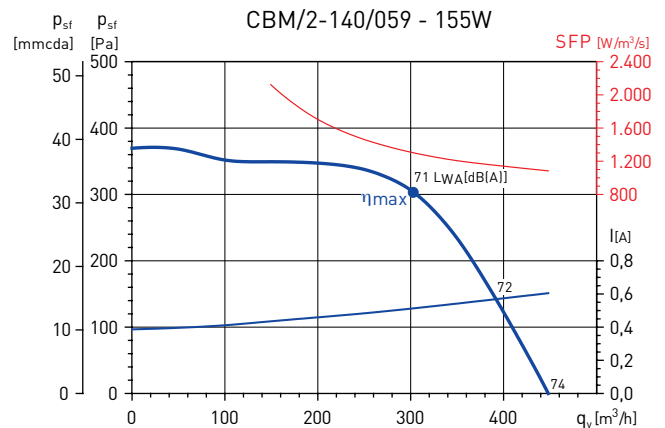
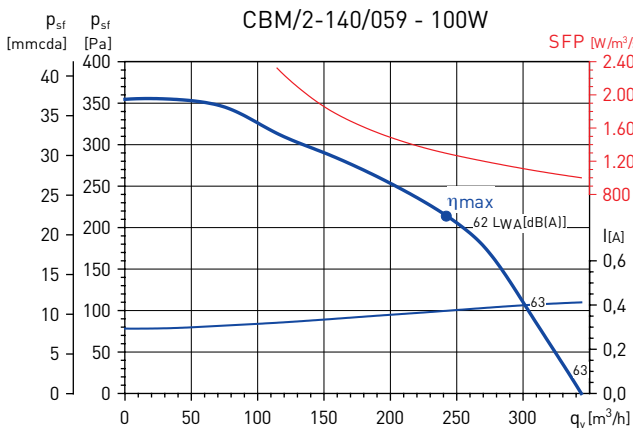
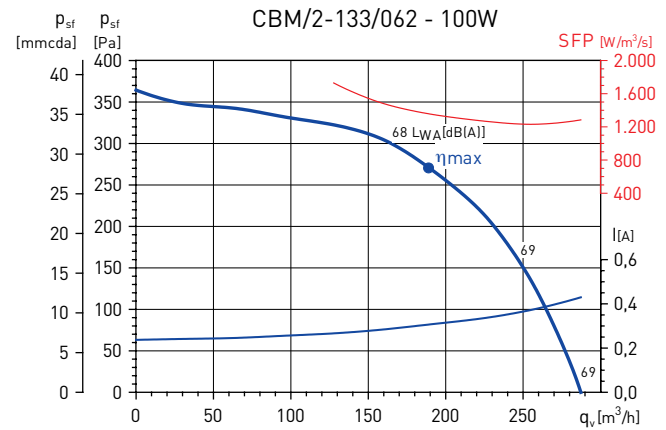
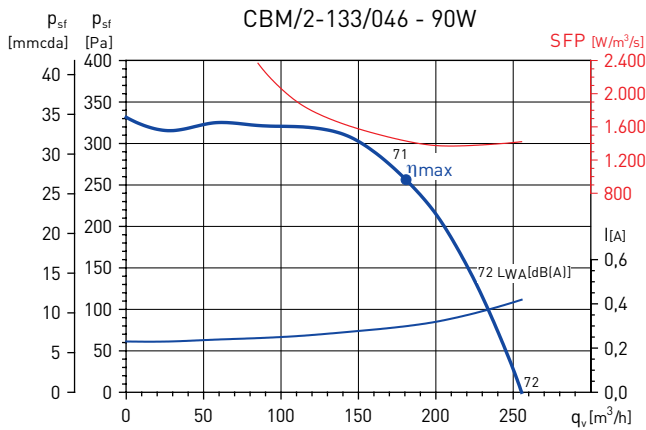

GRAFIEKEN

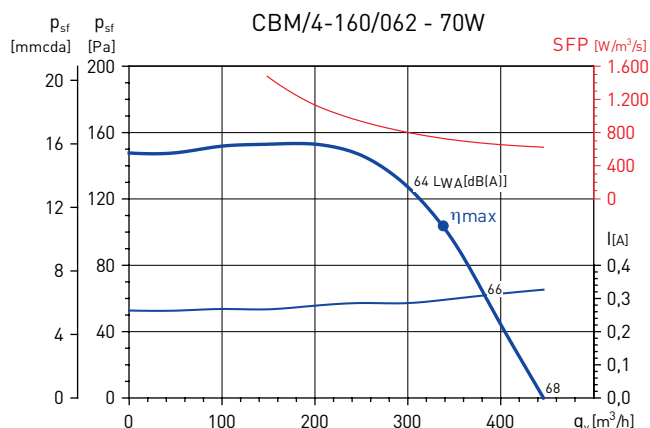
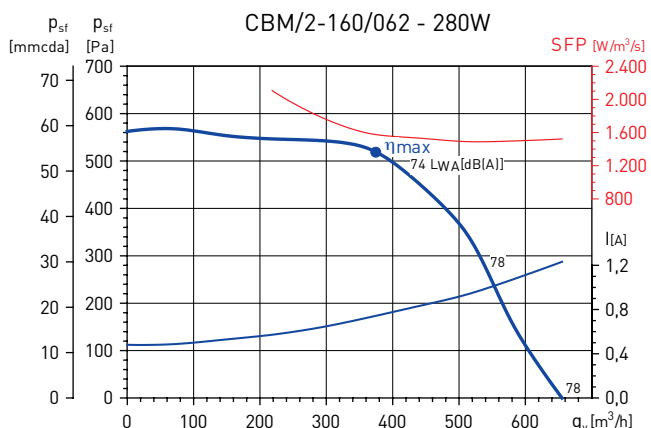

MC*	EC*	VSD*	SR*	η [%]*	N*	[kW]	[m³/h]	[Pa]	[RPM]
B	Total	No	1,006	37,7	49,0	0,164	374	596	2647

* Ver curva ejemplo.

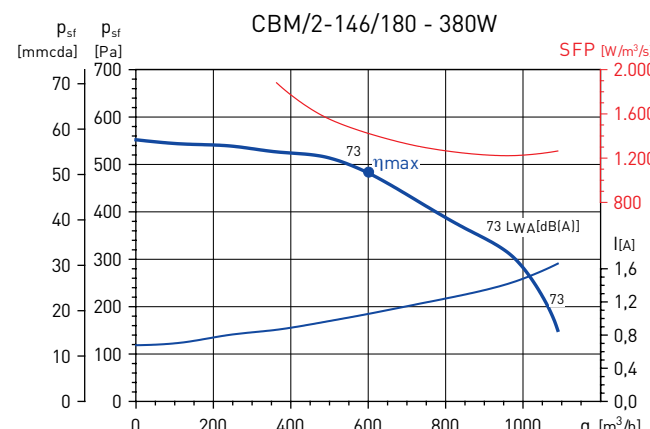
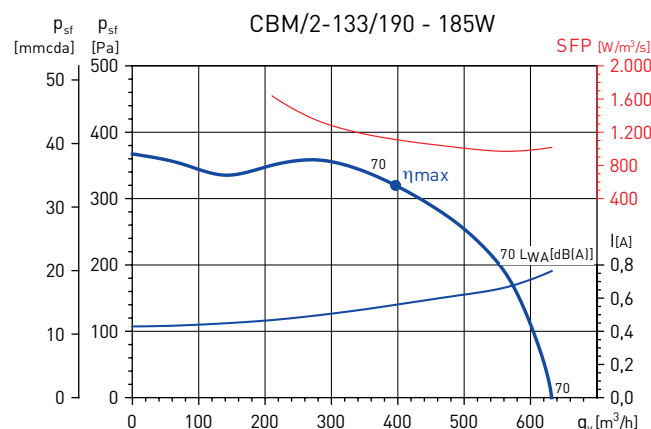
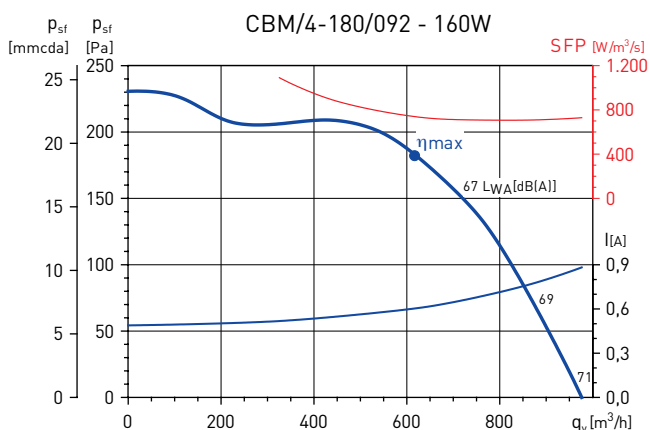
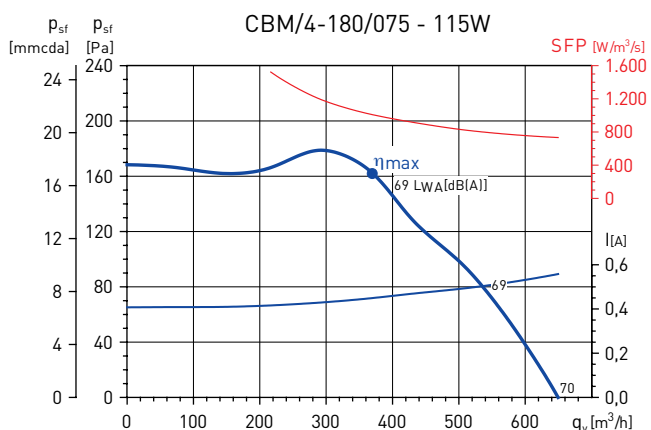

MC*	EC*	VSD*	SR*	η [%]*	N*	[kW]	[m³/h]	[Pa]	[RPM]
A	Static	No	1,005	33,9	44,2	0,237	599	482	2603

* Ver curva ejemplo.

GRAFIEKEN

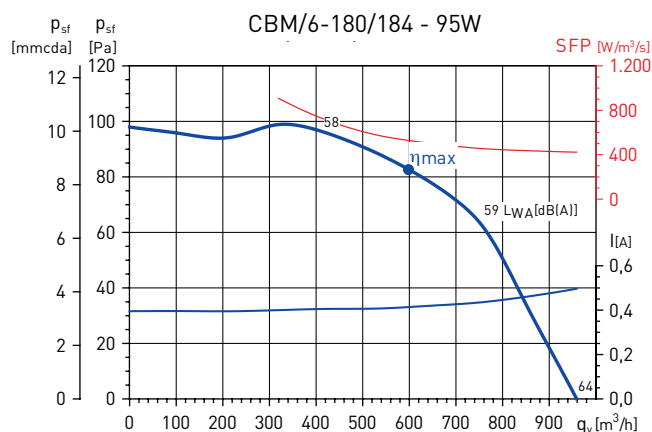
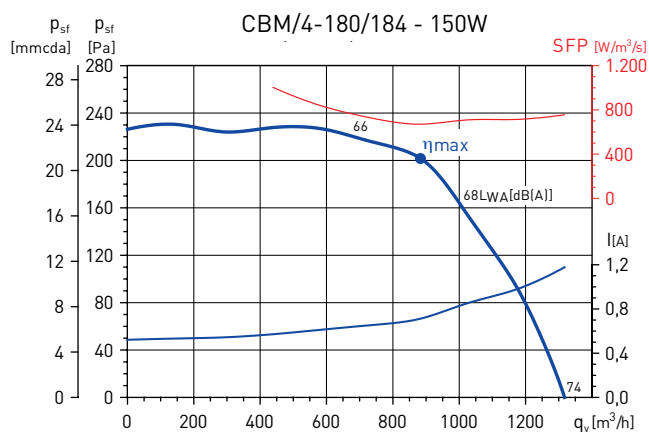
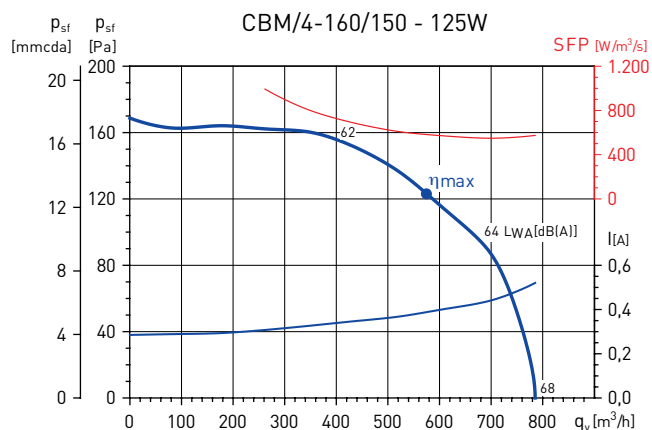
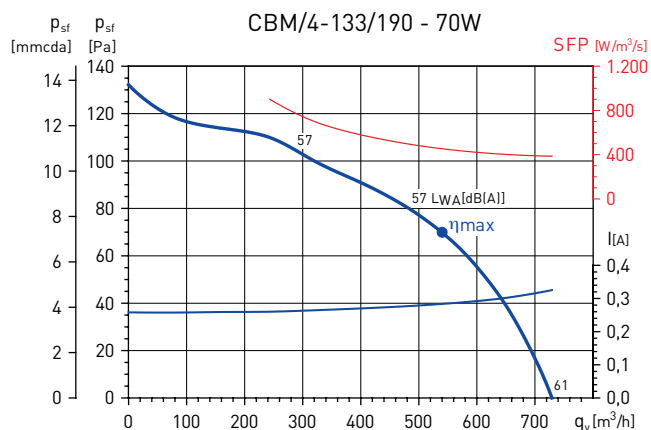

MC*	EC*	VSD*	SR*	η[%]*	N*	[kW]	[m³/h]	[Pa]	[RPM]
B	Total	No	1	37,7	49,0	0,164	883	253	1357

* Ver curva ejemplo.