

CC Versie

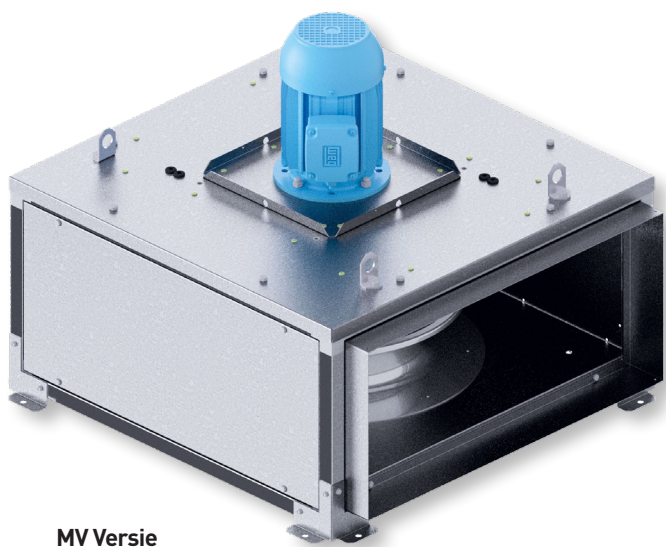

MV Versie

Toepassing

Afzuiging van rook en heet gas in geval van brand.
Afzuiging van muffe lucht in commerciële en industriële gebouwen.
Afzuiging van verontreinigende stoffen in professionele keukens.
Installatie in alle posities en aansluiting op alle zijden.
Luchtstroomtemperatuur tot 120 °C in geval van continue werking met motor bij omgevingslucht van max. 40 °C.

Assortiment

8 formaten: 355, 400, 450, 500, 560, 630, 710 en 800.

Bereik luchtprestaties van 500 tot 23.000 m³/u.

ILHT CC: Ventilator met multidirectioneel aanzuigplenum, en horizontale of verticale motoras.

ILHT MV: Enkel ventilatie-eenheid, horizontale of verticale motoras.

Opbouw

- Panelen van verzinkt staalplaat.
- Modulaire structuur met aluminiumprofielen.
- 4 montagebeugels.
- Rechthoekige kanaalkoppeling.
- Centrifugaal, achterwaarts gebogen schoep met directe aandrijving, vervaardigd uit verzinkte staalplaat.
- Volledige toegang voor reiniging en onderhoud zonder demontage van de ventilator van het kanaalsysteem.
- IP55 motor met isolatie van klasse F en door spanning regelbare 230 V 50 Hz eenfasenlucht of door frequentieomvormer regelbare 230/400 V 50 Hz driefasenlucht.

Op aanvraag:

Voor keukentoeepassingen:

- Verstevigde afsluiting met vetbestendige dichting.
- Condensafvoer meegeleverd maar niet gemonteerd.

Tweesnelheidsmotoren (niet conform de ErP-richtlijn).

Specifieke toepassingen



Officieel goedgekeurd conform EN12101-3



Continu bedrijf



Parkeer-garages



Commerciële en industriële keukens

TECHNISCHE GEGEVENS - CC VERSIE

Controleer voor de installatie of de elektrische gegevens van het product op het typeplaatje (spanning, vermogen, frequentie, etc.) passen bij de beoogde elektrische voeding.

Model type	Snelheid (rpm)	Motor vermogen (W)	Nominale stroom (A)		Maximale luchtstroom (m³/h)	Geluiddruk* (dB(A))			Gewicht (kg)	Frequentie regelaar			
			230V	400V		Inlaat	Uitstralend	Uitlaat		VFKB		VFTM	
										MONO	TRI	MONO	TRI
3-FASE 4 POLEN MOTOREN													
ILHT/4-355 CC	1410	0,25	1,4	0,8	3.370	57	50	63	59	24	45	0,37	0,37
ILHT/4-400 CC	1430	0,55	2,5	1,4	5.340	61	53	67	72	24	45	0,37	0,55
ILHT/4-450 CC	1460	1,1	4,1	2,3	7.860	66	59	72	92	24	45	0,75	1,1
ILHT/4-500 CC	1450	1,5	5,5	3,2	9.630	67	59	75	114	27	45	1,1	1,5
ILHT/4-560 CC	1440	2,2	7,9	4,6	12.470	69	58	72	159	27	48	2,2	2,2
3-FASE 6 POLEN MOTOREN													
ILHT/6-355 CC	900	0,18	1,3	0,7	2.110	48	41	54	59	24	45	0,18	0,37
ILHT/6-400 CC	930	0,37	2,0	1,1	3.410	52	44	58	72	24	45	0,37	0,37
ILHT/6-450 CC	930	0,37	2,0	1,1	4.940	57	50	63	92	24	45	0,37	0,37
ILHT/6-500 CC	930	0,55	2,8	1,6	6.090	59	50	66	114	24	45	0,37	0,55
ILHT/6-560 CC	930	0,75	3,4	1,9	7.960	60	49	63	159	24	45	0,55	0,75
ILHT/6-630 CC	930	1,1	4,7	2,7	11.800	64	54	68	162	27	45	1,1	1,1
ILHT/6-710 CC	980	3	12,0	6,9	18.910	68	61	74	264	-	48	-	4
ILHT/6-800 CC	970	4	15,6	9,0	25.660	70	61	72	307	-	-	-	5,5

* Geluiddruk gemeten in vrije veld condities, op 1,5 m.

AFMETINGEN (mm)

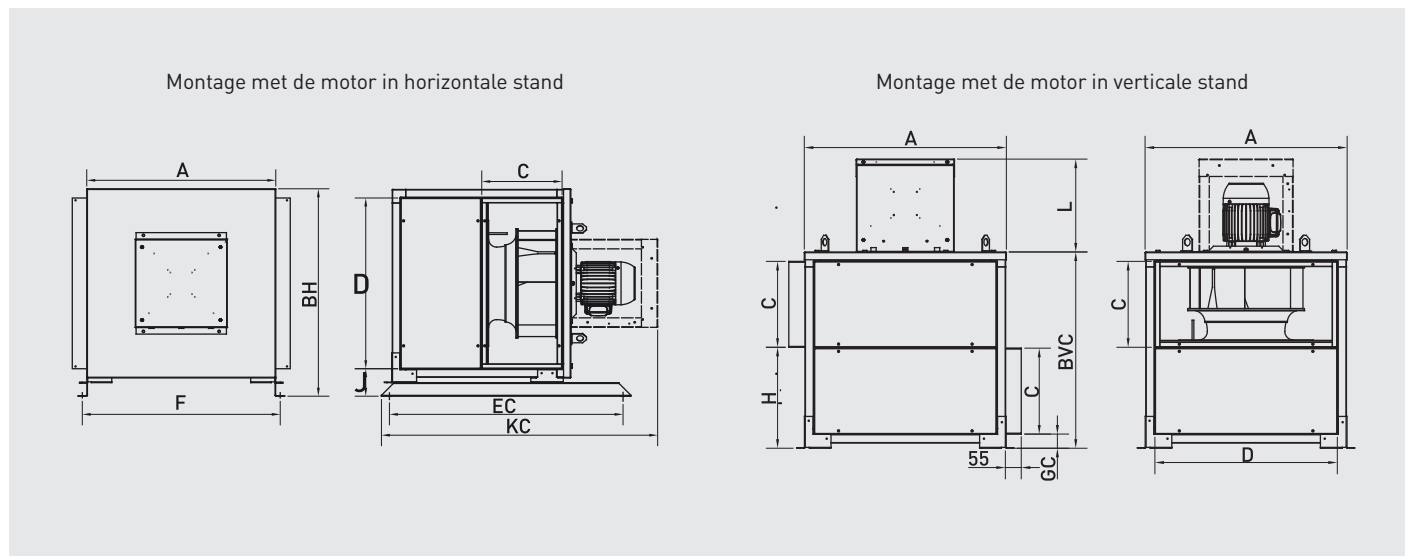

CC Model	A	BH	BVC	C	D	EC	F	GC	H	J	KC	L
355	627	695	645	263	559	790	660	50	315	102	954	321
400	699	767	678	297	631	864	732	50	349	102	1022	321
450	779	847	738	326	711	990	812	50	378	102	1081	321
500	858	925	784	338	768	1039	890	62	402	112	1145	351
560	954	1021	817	354	864	1139	986	62	419	112	1178	351
630	1066	1133	912	403	977	1183	1098	62	466	112	1273	351
710	1194	1261	1032	462	1104	1325	1226	62	526	112	1488	446
800	1338	1420	1084	488	1248	1379	1370	62	552	112	1540	446

TECHNISCHE GEGEVENS - MV VERSIE

Controleer voor de installatie of de elektrische gegevens van het product op het typeplaatje (spanning, vermogen, frequentie, etc.) passen bij de beoogde elektrische voeding.

Model type	Snelheid (rpm)	Motorvermogen (W)	Nominale stroom (A)		Maximale luchtstroom (m³/h)	Geluiddruk* (dB(A))			Gewicht (kg)	Frequentie regelaar			
			230V	400V		Inlaat	Uitstralend	Uitlaat		VFKB		VFTM	
										MONO	TRI	MONO	TRI
3-FASE 4 POLEN MOTOREN													
ILHT/4-355 MV	1410	0,25	1,4	0,8	3.550	57	46	59	39	24	45	0,37	0,37
ILHT/4-400 MV	1430	0,55	2,5	1,4	5.650	62	50	63	49	24	45	0,37	0,55
ILHT/4-450 MV	1450	1,1	4,1	2,3	8.320	66	55	67	67	24	45	0,75	1,1
ILHT/4-500 MV	1450	1,5	5,5	3,2	10.140	68	58	70	88	27	45	1,1	1,5
ILHT/4-560 MV	1450	2,2	7,9	4,6	12.900	69	58	72	111	27	48	2,2	2,2
3-FASE 6 POLEN MOTOREN													
ILHT/6-355 MV	900	0,18	1,3	0,7	2.220	48	37	50	39	24	45	0,18	0,37
ILHT/6-400 MV	930	0,37	2,0	1,1	3.600	53	41	54	49	24	45	0,37	0,37
ILHT/6-450 MV	930	0,37	2,0	1,1	5.240	57	46	59	67	24	45	0,37	0,37
ILHT/6-500 MV	930	0,55	2,8	1,6	6.430	59	49	61	88	24	45	0,37	0,55
ILHT/6-560 MV	940	0,75	3,4	1,9	8.300	60	49	63	111	24	45	0,55	0,75
ILHT/6-630 MV	940	1,1	4,7	2,7	12.260	64	56	65	118	27	45	1,1	1,1
ILHT/6-710 MV	980	3	12,0	6,9	19.690	68	63	72	144	-	48	-	4
ILHT/6-800 MV	970	4	15,6	9,0	24.820	70	65	72	224	-	-	-	5,5

* Geluiddruk gemeten in vrije veld condities, op 1,5 m.

AFMETINGEN (mm)

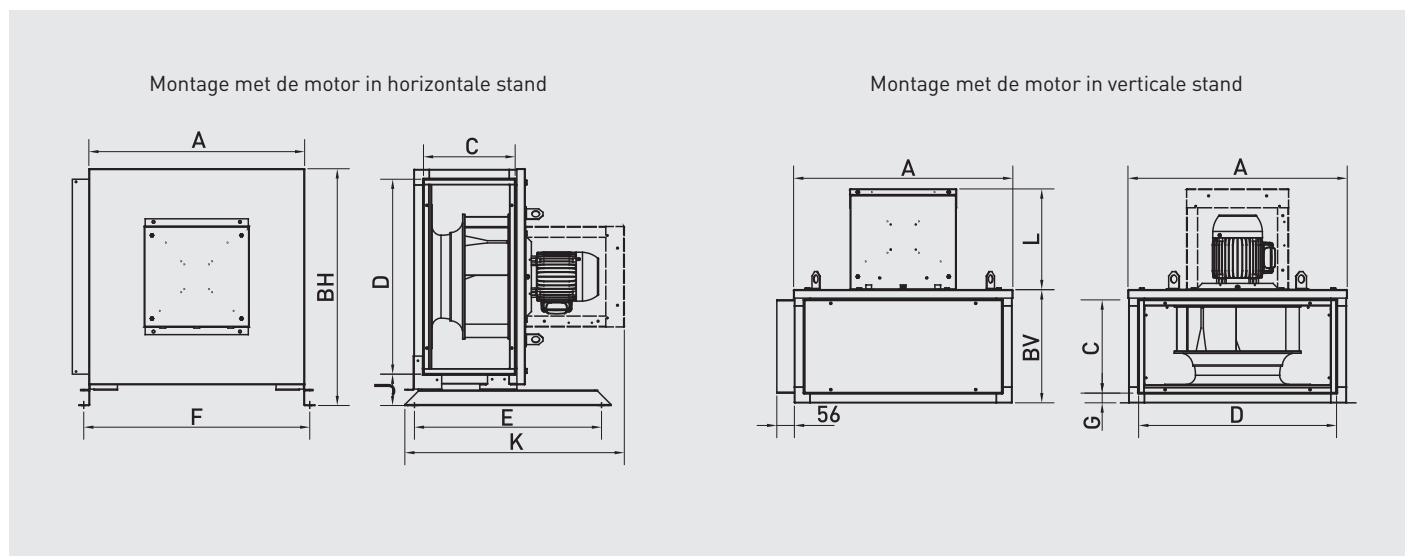

MV Model	A	BH	BV	C	D	E	F	G	J	K	L
355	627	695	327	263	559	606	660	31	102	677	321
400	699	767	361	297	631	606	732	31	102	711	321
450	779	847	392	326	711	606	812	31	102	743	321
500	858	925	424	338	768	700	890	42	112	805	351
560	954	1021	441	354	864	700	986	42	112	822	351
630	1066	1133	488	403	977	700	1098	42	112	869	351
710	1194	1261	551	462	1104	906	1226	42	112	994	446
800	1338	1420	574	488	1248	906	1370	42	112	1050	446

PRESTATIECURVES

- q_v : Luchtstroom in m^3/h en m^3/s .
- p_{sf} : Statische druk in mmWG en Pa.
- Droge lucht bij 20°C en 760 mmHg.
- Gegevens over prestatievermogen in overeenstemming met ISO 5801 en AMCA 210-99 normen.

ILHT/4-355 CC 0,25kW

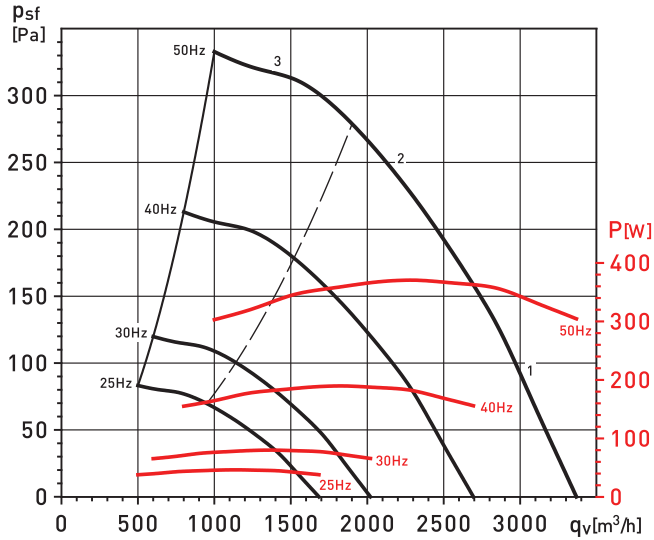

ILHT/4-355		63	125	250	500	1000	2000	4000	8000	LwA
INLAAT	1	50	70	65	66	68	67	63	54	75
	2	46	66	60	63	66	64	60	52	72
	3	53	63	59	62	63	61	56	49	69
Uitlaat	1	46	74	73	72	74	72	67	59	80
	2	42	70	69	69	73	69	63	56	77
	3	49	66	68	68	70	65	59	52	75
Uitstralend	1	46	59	56	53	58	56	51	44	64
	2	46	59	56	53	58	56	51	44	64
	3	54	57	55	52	54	52	47	41	62

ILHT/4-400 CC 0,55kW

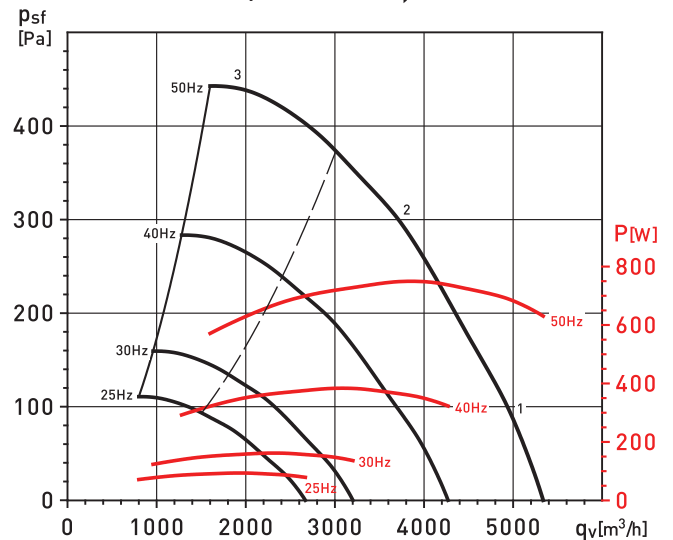

ILHT/4-400		63	125	250	500	1000	2000	4000	8000	LwA
Inlaat	1	57	72	71	72	72	73	68	60	79
	2	50	69	66	67	69	70	64	57	76
	3	56	67	63	66	67	66	61	56	73
Uitlaat	1	53	76	80	79	81	77	73	66	86
	2	48	73	74	74	76	74	69	62	82
	3	54	70	73	73	75	70	63	57	80
Uitstralend	1	54	65	67	61	63	65	58	51	72
	2	48	61	62	56	59	61	55	49	68
	3	54	59	59	56	58	58	51	48	66

ILHT/4-450 CC 1,1kW

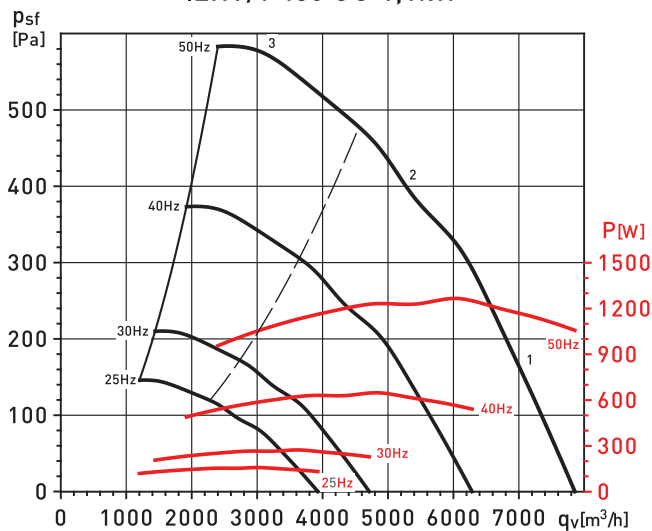

ILHT/4-450		63	125	250	500	1000	2000	4000	8000	LwA
Inlaat	1	60	76	75	76	76	76	72	65	83
	2	56	70	73	73	74	74	69	64	80
	3	60	70	70	72	71	71	67	63	78
Uitlaat	1	62	78	85	85	87	82	78	71	91
	2	57	74	80	80	82	78	72	66	87
	3	60	72	78	78	80	74	67	61	84
Uitstralend	1	55	69	71	68	69	68	64	57	76
	2	50	63	69	65	67	65	60	55	73
	3	54	63	66	64	64	62	59	54	71

ILHT/4-500 CC 1,5kW

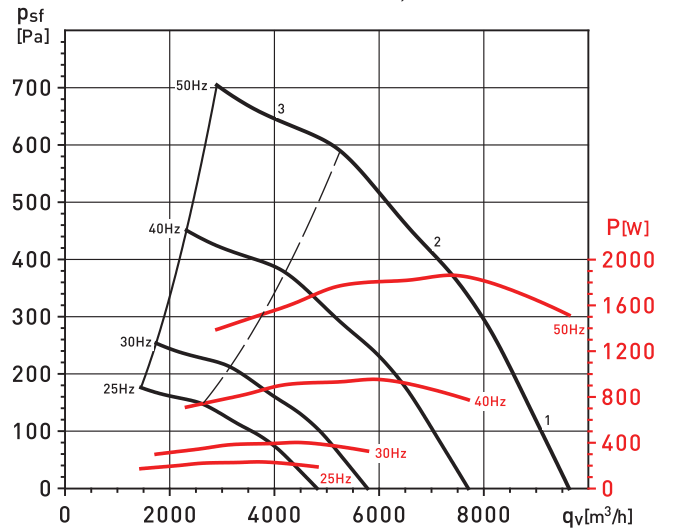

ILHT/4-500		63	125	250	500	1000	2000	4000	8000	LwA
Inlaat	LP 1	73	76	77	79	79	79	74	68	85
	MP 2	70	72	74	77	75	75	70	65	82
	HP 3	71	71	73	75	72	72	67	61	80
Uitlaat	LP 1	81	88	87	90	84	80	72	64	94
	MP 2	76	82	82	86	79	75	68	61	89
	HP 3	75	81	80	83	76	70	63	57	87
Uitstralend	LP 1	63	69	66	73	67	62	55	48	76
	MP 2	60	64	62	71	63	58	52	47	73
	HP 3	61	63	61	68	60	55	48	43	71

PRESTATIECURVES

- q_v : Luchtstroom in m^3/h en m^3/s .
- p_{sf} : Statische druk in mmWG en Pa.
- Droge lucht bij 20°C en 760 mmHg.
- Gegevens over prestatievermogen in overeenstemming met ISO 5801 en AMCA 210-99 normen.

ILHT/4-560 CC 2,2kW

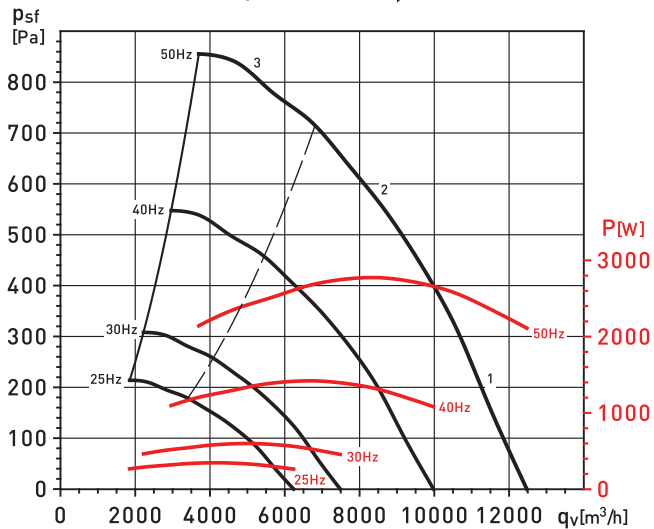

ILHT/4-560		63	125	250	500	1000	2000	4000	8000	LwA
Inlaat	1	58	76	75	73	80	78	75	69	85
	2	57	73	72	74	79	77	73	67	83
	3	63	79	75	74	78	74	70	65	84
Uitlaat	1	60	81	82	80	83	80	78	73	89
	2	59	79	79	77	82	79	76	70	87
	3	63	79	80	78	81	77	73	67	86
Uitstralend	1	47	66	67	64	69	66	62	55	74
	2	46	62	64	64	68	65	60	53	73
	3	52	68	67	65	67	62	57	51	73

PRESTATIECURVES

- q_v : Luchtstroom in m^3/h en m^3/s .
- p_{sf} : Statische druk in mmWG en Pa.
- Droge lucht bij 20°C en 760 mmHg.
- Gegevens over prestatievermogen in overeenstemming met ISO 5801 en AMCA 210-99 normen.

ILHT/6-355 CC 0,18kW

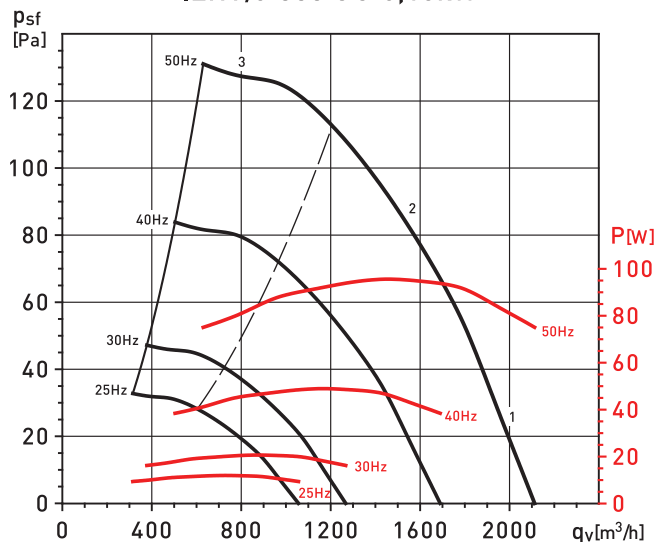

ILHT/6-355		63	125	250	500	1000	2000	4000	8000	LwA
Inlaat	1	41	61	56	57	59	58	54	45	66
	2	37	57	51	54	57	56	51	43	63
	3	44	54	50	53	54	52	47	40	60
Uitlaat	1	37	65	64	63	66	63	58	50	71
	2	33	61	60	60	64	60	54	47	68
	3	40	58	60	59	61	57	50	43	66
Uitstralend	1	41	55	52	48	51	49	45	37	59
	2	37	51	47	44	49	47	42	35	55
	3	45	48	46	43	45	43	39	32	53

ILHT/6-400 CC 0,37kW

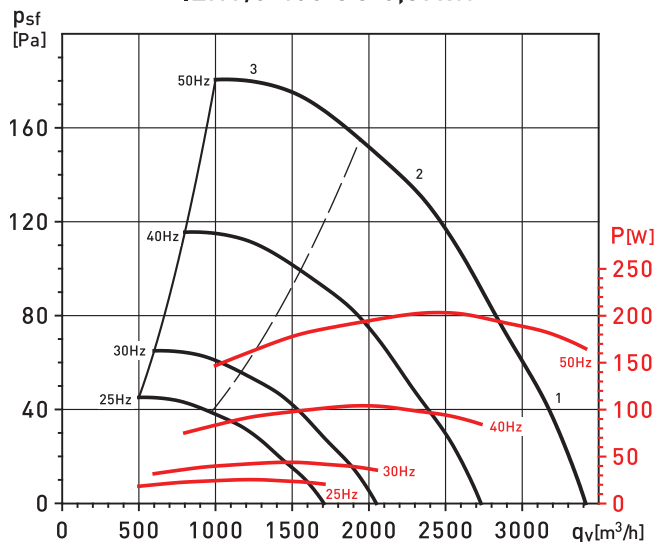

ILHT/6-400		63	125	250	500	1000	2000	4000	8000	LwA
Inlaat	1	48	64	62	63	64	64	59	51	71
	2	41	60	57	58	60	61	56	48	67
	3	47	58	54	58	58	57	52	48	65
Uitlaat	1	44	68	71	70	72	69	64	57	77
	2	40	64	66	65	67	65	60	53	73
	3	45	61	65	64	66	61	54	48	71
Uitstralend	1	45	56	58	52	54	56	50	43	63
	2	39	52	53	47	51	52	46	40	59
	3	45	50	50	47	49	49	43	39	57

ILHT/6-450 CC 0,37kW

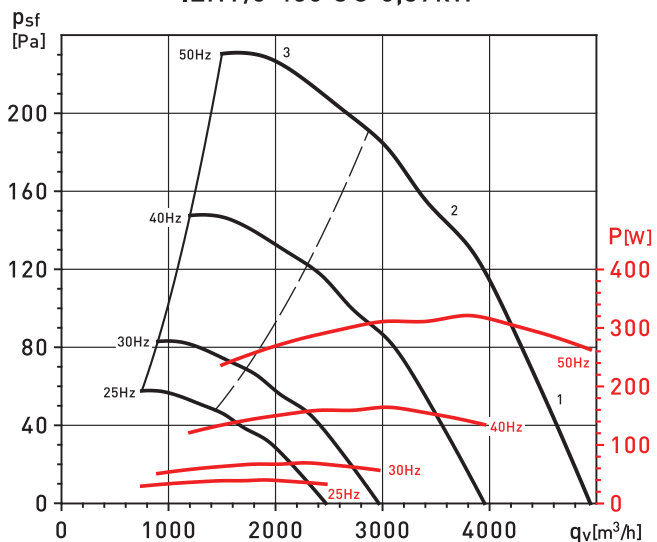

ILHT/6-450		63	125	250	500	1000	2000	4000	8000	LwA
Inlaat	1	51	67	67	67	67	68	63	57	74
	2	47	61	64	64	65	65	60	55	71
	3	51	61	61	63	62	62	59	54	69
Uitlaat	1	53	69	76	76	78	73	69	62	82
	2	49	65	71	71	73	69	63	57	78
	3	51	64	70	70	71	65	58	52	76
Uitstralend	1	46	60	63	59	60	59	55	48	68
	2	41	54	60	56	58	56	52	46	65
	3	46	54	57	55	55	53	50	45	62

ILHT/6-500 CC 0,55kW

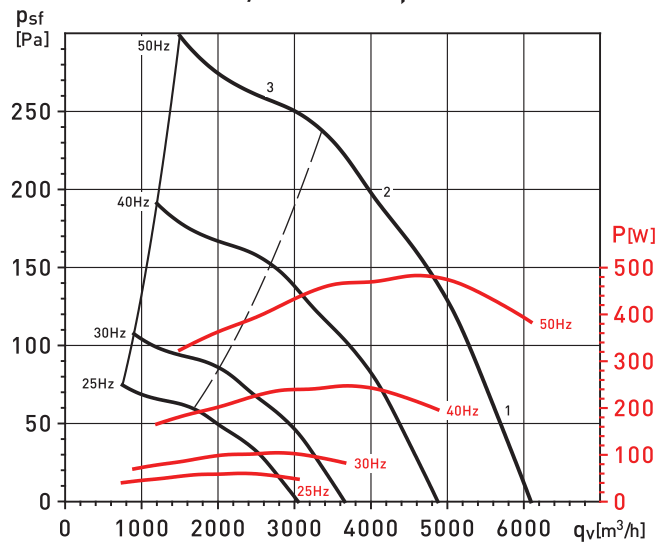

ILHT/6-500		63	125	250	500	1000	2000	4000	8000	LwA
Inlaat	1	55	64	68	68	70	70	65	59	76
	2	54	61	63	65	69	67	61	56	73
	3	56	62	62	64	66	64	58	53	71
Uitlaat	1	57	72	79	78	81	75	71	63	85
	2	53	68	73	74	77	71	66	60	81
	3	55	66	72	72	74	67	61	54	78
Uitstralend	1	45	55	60	57	64	58	53	46	67
	2	43	51	55	53	62	54	49	43	64
	3	46	52	54	52	59	51	46	40	62

PRESTATIECURVES

- q_v : Luchtstroom in m^3/h en m^3/s .
- p_{st} : Statische druk in mmWG en Pa.
- Droge lucht bij 20°C en 760 mmHg.
- Gegevens over prestatievermogen in overeenstemming met ISO 5801 en AMCA 210-99 normen.

ILHT/6-560 CC 0,75kW

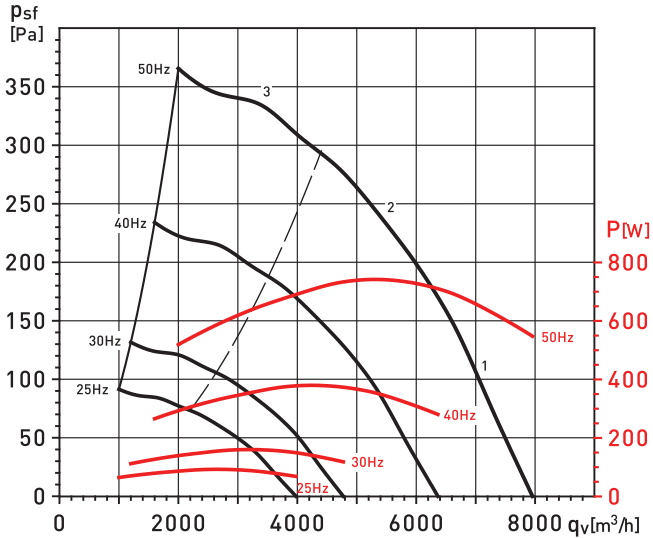

ILHT/6-560		63	125	250	500	1000	2000	4000	8000	LwA
Inlaat	1	49	68	66	64	71	70	66	61	76
	2	48	64	63	65	70	69	64	59	75
	3	55	70	66	65	69	66	61	57	75
Uitlaat	1	51	72	73	71	74	71	69	64	80
	2	50	70	70	69	73	70	67	61	78
	3	54	70	71	69	72	68	64	58	78
Uitstralend	1	38	57	59	55	60	58	53	46	65
	2	37	53	56	56	59	57	51	44	64
	3	43	59	58	56	58	54	48	42	65

ILHT/6-630 CC 1,5kW

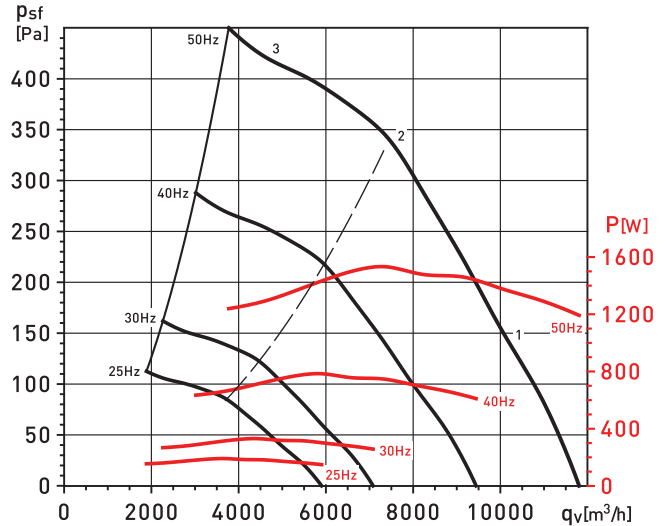

ILHT/6-630		63	125	250	500	1000	2000	4000	8000	LwA
Inlaat	1	64	72	75	74	77	74	69	62	82
	2	59	69	70	70	74	71	65	59	78
	3	63	67	69	69	72	67	62	57	77
Uitlaat	1	64	76	78	80	81	76	71	64	86
	2	61	71	74	76	78	73	68	61	82
	3	64	71	75	75	76	70	64	58	81
Uitstralend	1	57	68	64	63	66	64	57	51	73
	2	52	64	59	60	63	60	53	48	69
	3	57	63	59	59	61	56	50	46	68

ILHT/6-710 CC 3kW

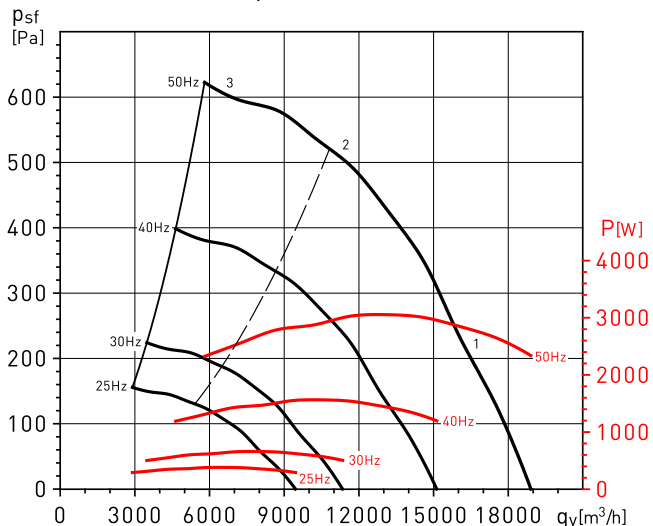

ILHT/6-710		63	125	250	500	1000	2000	4000	8000	LwA
Inlaat	1	70	76	77	78	80	76	69	64	85
	2	69	73	75	76	77	73	68	64	82
	3	70	70	74	75	76	72	68	65	81
Uitlaat	1	70	85	86	89	89	82	75	68	94
	2	66	79	81	83	83	76	70	65	88
	3	70	78	81	83	81	74	68	63	87
Uitstralend	1	59	72	69	74	70	63	54	48	78
	2	58	68	67	72	67	60	52	49	75
	3	59	66	66	71	66	59	53	49	74

ILHT/6-800 CC 4kW

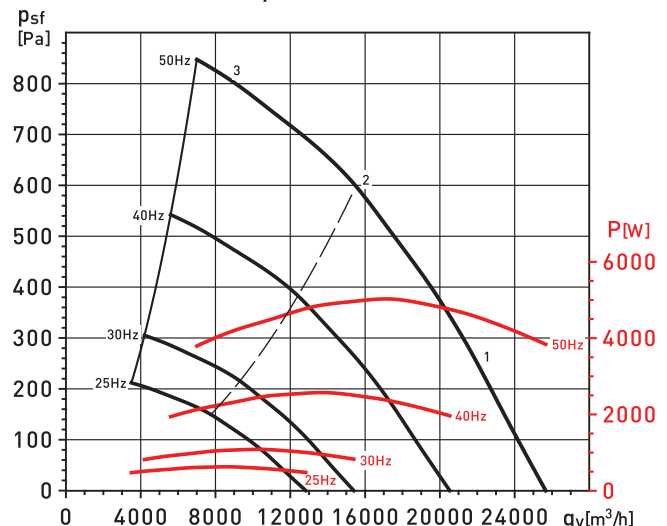

ILHT/6-800		63	125	250	500	1000	2000	4000	8000	LwA
Inlaat	1	59	75	73	75	80	78	72	67	85
	2	61	73	73	76	81	77	72	70	85
	3	70	76	75	75	77	73	71	67	83
Uitlaat	1	68	85	85	88	88	85	78	75	93
	2	63	78	78	81	82	77	72	71	87
	3	69	78	79	80	80	76	72	69	86
Uitstralend	1	51	68	64	62	70	69	64	67	75
	2	53	65	64	62	70	67	63	69	75
	3	61	68	65	61	66	62	61	65	74

PRESTATIECURVES

- q_v : Luchtstroom in m^3/h en m^3/s .
- p_{sf} : Statische druk in mmWG en Pa.
- Droge lucht bij 20°C en 760 mmHg.
- Gegevens over prestatievermogen in overeenstemming met ISO 5801 en AMCA 210-99 normen.

ILHT/4-355 MV 0,25kW

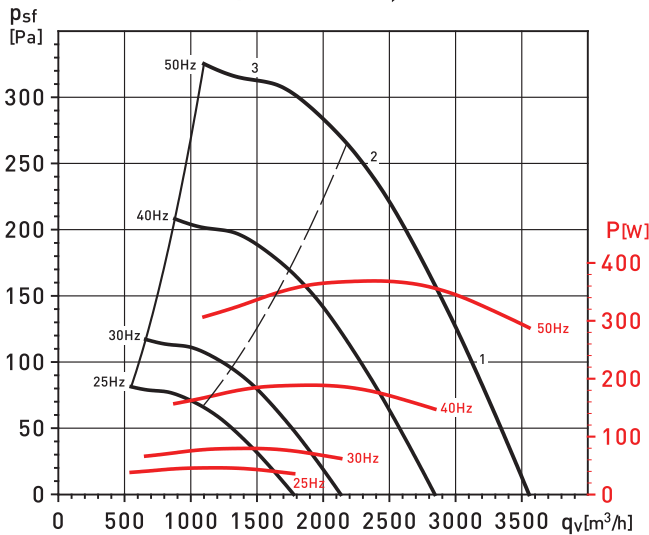

ILHT/4-355		63	125	250	500	1000	2000	4000	8000	LwA
Inlaat	1	42	67	65	61	66	67	64	59	74
	2	41	65	62	59	66	64	60	57	71
	3	52	66	65	61	65	61	57	52	71
Uitlaat	1	42	67	69	67	69	69	65	59	76
	2	40	65	66	65	66	66	61	55	73
	3	51	66	68	66	66	64	57	51	73
Uitstralend	1	41	53	49	49	54	55	51	50	60
	2	41	53	49	49	54	55	51	50	60
	3	52	54	52	51	53	52	48	45	61

ILHT/4-400 MV 0,55kW

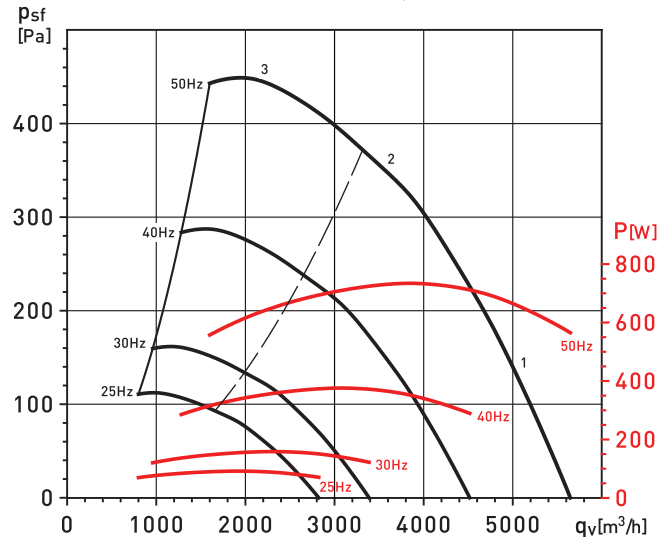

ILHT/4-400		63	125	250	500	1000	2000	4000	8000	LwA
Inlaat	1	46	76	72	66	70	72	68	65	80
	2	43	73	68	64	68	69	65	60	77
	3	54	72	69	65	67	67	63	58	76
Uitlaat	1	48	71	73	73	75	74	70	64	81
	2	44	68	70	69	72	70	67	60	77
	3	55	70	72	70	72	68	62	55	78
Uitstralend	1	43	63	61	56	59	59	54	48	68
	2	40	59	57	53	57	57	52	43	64
	3	51	59	58	55	56	54	49	42	64

ILHT/4-450 MV 1,1kW

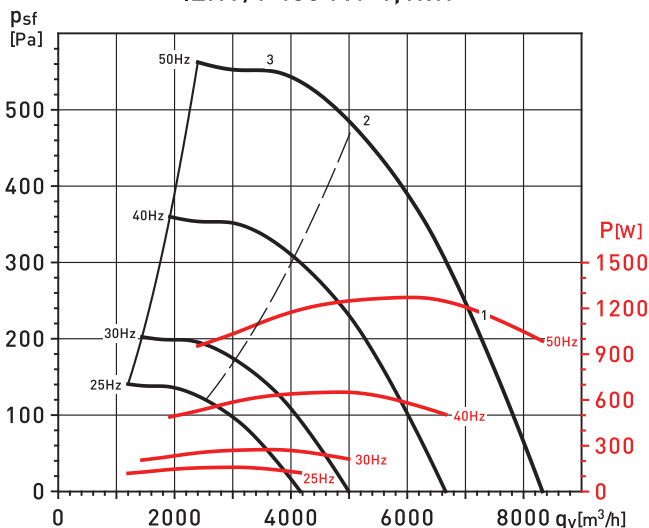

ILHT/4-450		63	125	250	500	1000	2000	4000	8000	LwA
Inlaat	1	53	77	74	70	76	75	72	67	82
	2	51	75	71	69	74	73	70	65	80
	3	62	75	73	70	73	70	66	61	80
Uitlaat	1	53	76	78	76	78	77	74	69	85
	2	50	73	74	74	76	75	71	66	82
	3	58	73	76	75	76	72	67	61	82
Uitstralend	1	50	68	62	59	64	64	62	53	72
	2	49	65	59	58	62	62	60	51	70
	3	59	66	61	59	62	59	56	47	70

ILHT/4-500 MV 1,5kW

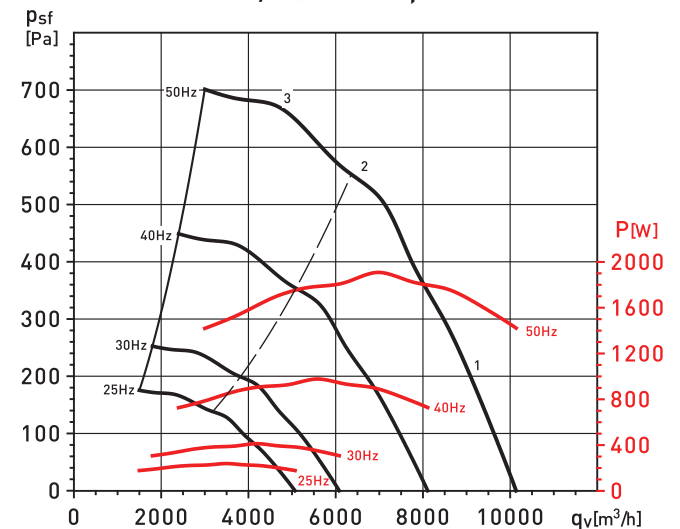

ILHT/4-500		63	125	250	500	1000	2000	4000	8000	LwA
Inlaat	1	58	74	73	73	78	77	75	70	83
	2	54	75	70	70	78	76	73	72	82
	3	57	75	71	71	76	74	73	70	82
Uitlaat	1	59	77	80	78	81	78	76	71	87
	2	56	75	76	75	80	77	74	70	84
	3	60	76	77	76	79	75	71	67	84
Uitstralend	1	50	65	65	63	67	66	65	59	73
	2	46	65	62	60	67	65	62	61	72
	3	49	66	63	61	66	63	63	58	72

PRESTATIECURVES

- q_v : Luchtstroom in m^3/h en m^3/s .
- p_{sf} : Statische druk in mmWG en Pa.
- Droge lucht bij 20°C en 760 mmHg.
- Gegevens over prestatievermogen in overeenstemming met ISO 5801 en AMCA 210-99 normen.

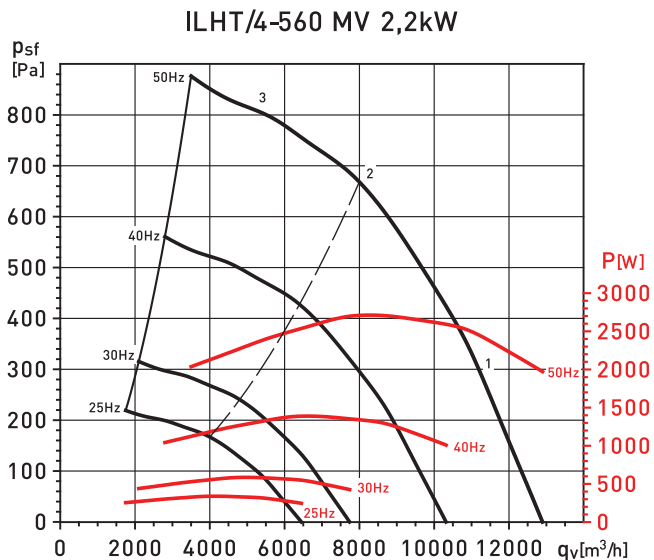

ILHT/4-560		63	125	250	500	1000	2000	4000	8000	LwA
Inlaat	1	58	76	75	73	80	78	75	69	85
	2	57	73	72	74	79	77	73	67	83
	3	63	79	75	74	78	74	70	65	84
Uitlaat	1	60	81	82	80	83	80	78	73	89
	2	59	79	79	77	82	79	76	70	87
	3	63	79	80	78	81	77	73	67	86
Uitstralend	1	47	66	67	64	69	66	62	55	74
	2	46	62	64	64	68	65	60	53	73
	3	52	68	67	65	67	62	57	51	73

PRESTATIECURVES

- q_v : Luchtstroom in m^3/h en m^3/s .
- p_{sf} : Statische druk in mmWG en Pa.
- Droge lucht bij 20°C en 760 mmHg.
- Gegevens over prestatievermogen in overeenstemming met ISO 5801 en AMCA 210-99 normen.

ILHT/6-355 MV 0,18kW

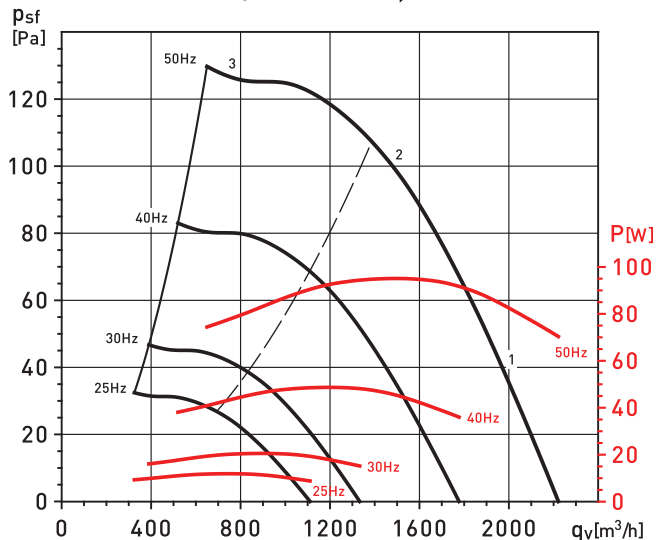

ILHT/6-355		63	125	250	500	1000	2000	4000	8000	LwA
Inlaat	1	33	59	56	52	57	59	55	50	65
	2	32	56	53	50	57	55	52	48	62
	3	43	57	56	52	56	52	48	44	63
Uitlaat	1	33	58	60	58	60	60	56	50	67
	2	31	56	58	56	58	57	52	46	64
	3	42	57	59	58	57	55	48	42	64
Uitstralend	1	34	46	44	43	46	49	46	43	54
	2	33	44	40	41	45	46	42	41	52
	3	43	45	44	43	44	43	39	37	52

ILHT/6-400 MV 0,37kW

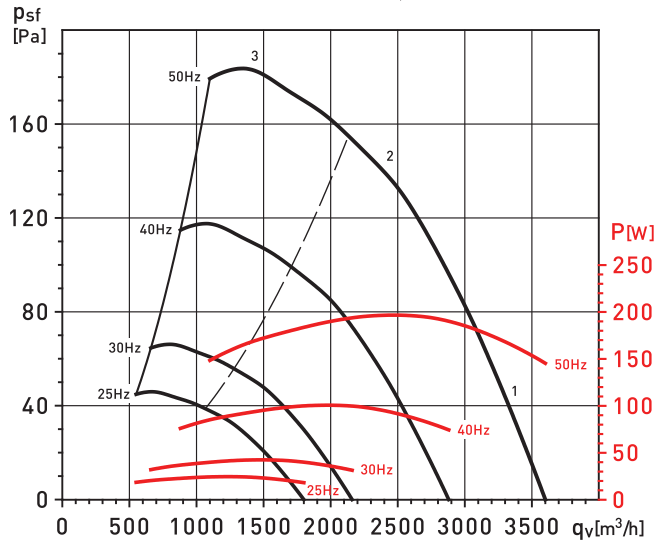

ILHT/6-400		63	125	250	500	1000	2000	4000	8000	LwA
Inlaat	1	37	68	64	58	61	63	59	56	71
	2	35	64	59	55	59	60	57	51	68
	3	45	63	61	56	59	58	54	50	67
Uitlaat	1	39	62	65	64	66	65	62	56	72
	2	35	59	61	60	63	61	58	51	68
	3	46	61	63	61	63	59	53	46	69
Uitstralend	1	34	54	52	47	50	51	45	39	59
	2	31	51	48	44	48	48	43	34	56
	3	42	50	49	46	48	46	40	33	55

ILHT/6-450 MV 0,37kW

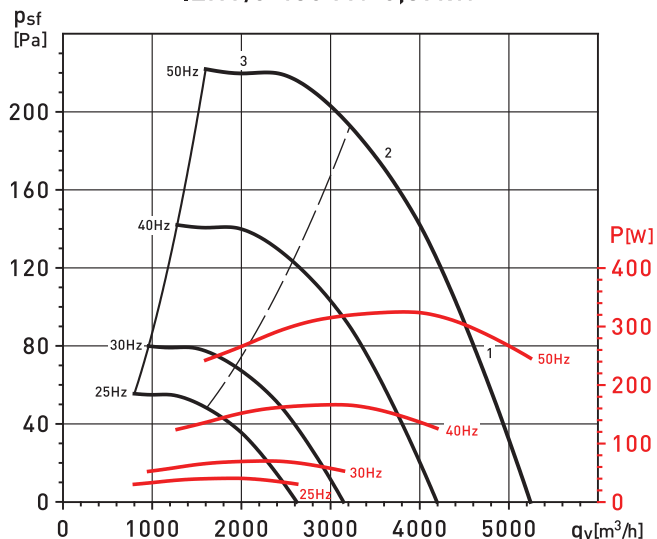

ILHT/6-450		63	125	250	500	1000	2000	4000	8000	LwA
Inlaat	1	44	68	65	61	67	66	63	58	74
	2	42	66	62	60	65	64	61	56	71
	3	53	66	64	62	64	61	57	52	71
Uitlaat	1	44	67	69	68	70	68	65	60	76
	2	41	65	65	65	67	66	62	57	73
	3	49	65	67	66	67	63	58	52	73
Uitstralend	1	41	59	54	50	55	55	53	44	63
	2	40	57	51	49	54	53	51	42	61
	3	50	57	52	50	53	50	47	38	61

ILHT/6-500 MV 0,55kW

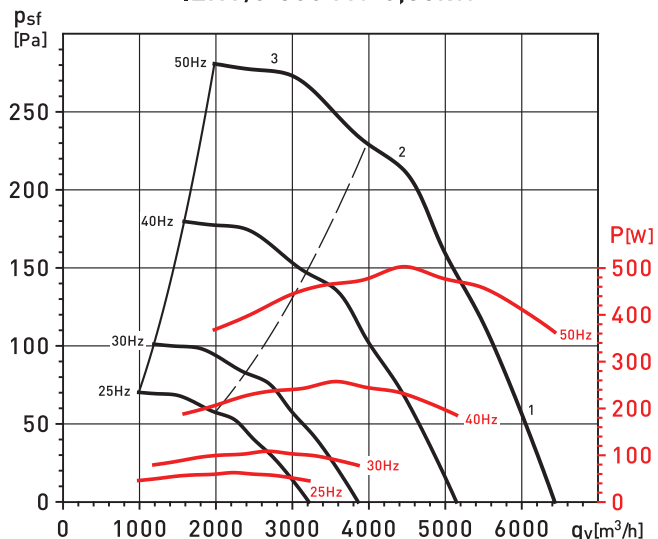

ILHT/6-500		63	125	250	500	1000	2000	4000	8000	LwA
Inlaat	1	49	65	64	64	69	69	66	61	75
	2	45	66	61	61	69	67	64	63	74
	3	48	66	62	62	68	66	64	61	73
Uitlaat	1	50	69	71	69	73	70	67	62	78
	2	47	67	67	66	71	68	65	61	76
	3	51	67	69	67	70	66	62	58	75
Uitstralend	1	41	56	56	54	59	58	56	50	65
	2	37	56	53	52	58	56	54	52	63
	3	40	57	54	52	57	55	54	50	63

PRESTATIECURVES

- q_v : Luchtstroom in m^3/h en m^3/s .
- p_{sf} : Statische druk in mmWG en Pa.
- Droge lucht bij 20°C en 760 mmHg.
- Gegevens over prestatievermogen in overeenstemming met ISO 5801 en AMCA 210-99 normen.

ILHT/6-560 MV 0,75kW

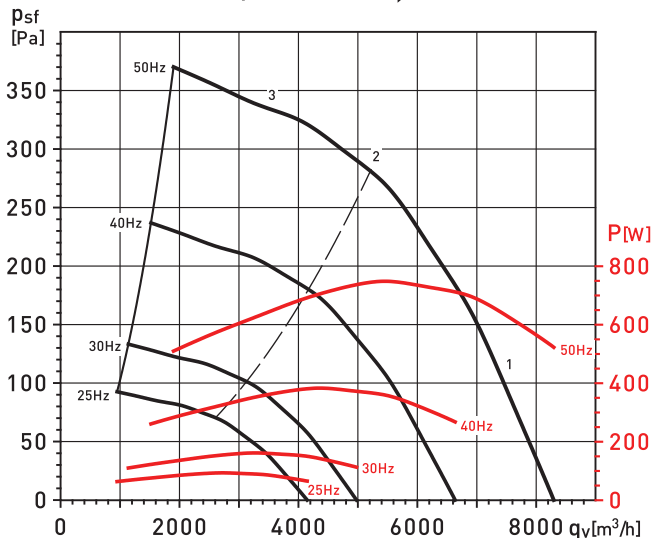

ILHT/6-560		63	125	250	500	1000	2000	4000	8000	LwA
Inlaat	1	49	68	66	64	71	70	66	61	76
	2	48	64	63	65	70	69	64	59	75
	3	55	70	66	65	69	66	61	57	75
Uitlaat	1	51	72	73	71	74	71	69	64	80
	2	50	70	70	69	73	70	67	61	78
	3	54	70	71	69	72	68	64	58	78
Uitstralend	1	38	57	59	55	60	58	53	46	65
	2	37	53	56	56	59	57	51	44	64
	3	43	59	58	56	58	54	48	42	65

ILHT/6-630 MV 1,5kW

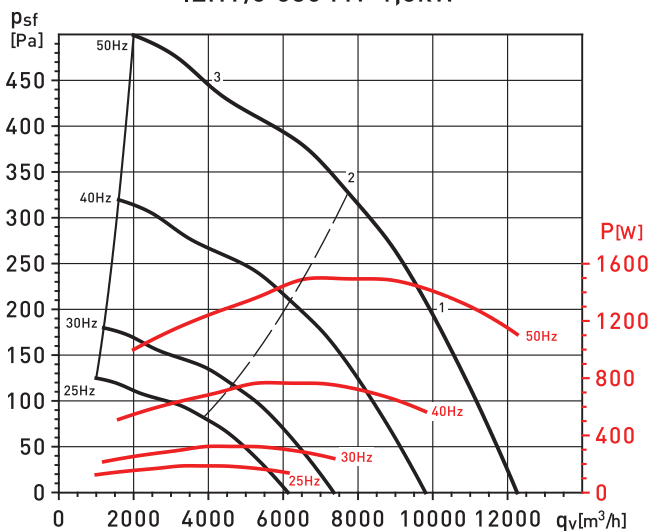

ILHT/6-630		63	125	250	500	1000	2000	4000	8000	LwA
Inlaat	1	54	72	69	68	74	73	68	63	79
	2	56	69	68	68	74	71	68	67	78
	3	63	70	70	68	71	67	63	63	77
Uitlaat	1	56	70	73	74	77	73	69	63	81
	2	56	68	71	72	76	71	66	61	80
	3	62	69	74	74	75	68	63	61	80
Uitstralend	1	45	61	61	61	64	64	61	59	70
	2	48	58	60	60	64	63	61	63	70
	3	54	60	61	60	61	58	56	59	68

ILHT/6-710 MV 3kW

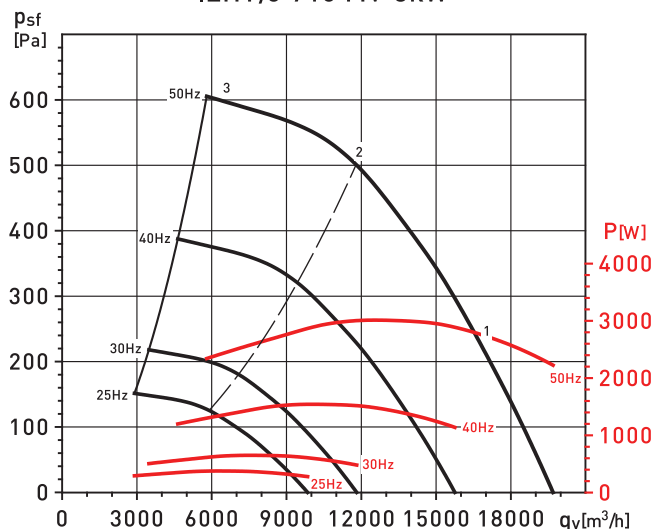

ILHT/6-710		63	125	250	500	1000	2000	4000	8000	LwA
Inlaat	1	59	76	72	77	80	77	71	66	84
	2	65	76	75	77	76	72	66	62	83
	3	69	75	73	77	76	73	68	63	82
Uitlaat	1	67	78	81	84	83	79	73	69	89
	2	62	74	79	83	81	76	71	68	87
	3	68	74	80	83	80	74	70	68	87
Uitstralend	1	54	71	66	73	75	71	66	61	79
	2	59	71	69	73	71	65	62	58	78
	3	63	69	67	73	71	66	63	59	78

ILHT/6-800 MV 4kW

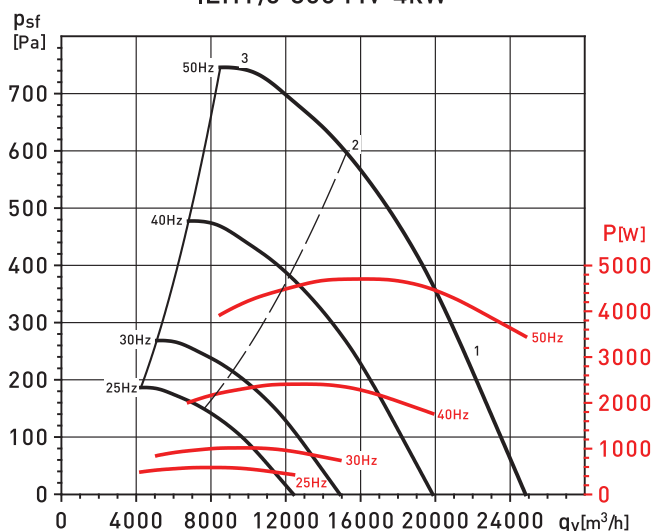

ILHT/6-800		63	125	250	500	1000	2000	4000	8000	LwA
Inlaat	1	60	76	74	76	81	79	73	68	86
	2	61	73	73	76	81	77	72	70	85
	3	71	78	76	76	79	74	72	68	84
Uitlaat	1	63	79	80	82	82	80	73	69	88
	2	63	78	78	80	81	77	72	71	87
	3	69	78	79	80	80	76	72	69	86
Uitstralend	1	55	72	68	67	74	73	68	71	80
	2	56	69	67	66	74	71	67	73	79
	3	67	74	70	67	71	68	67	71	79

MONTAGE ACCESSOIRES

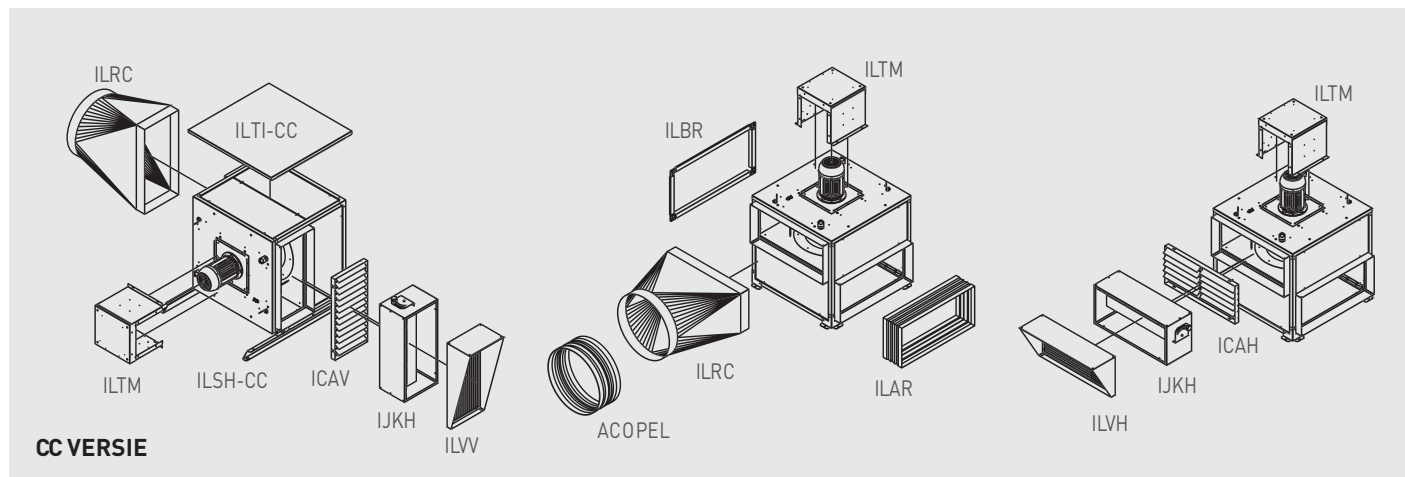

CC VERSIE

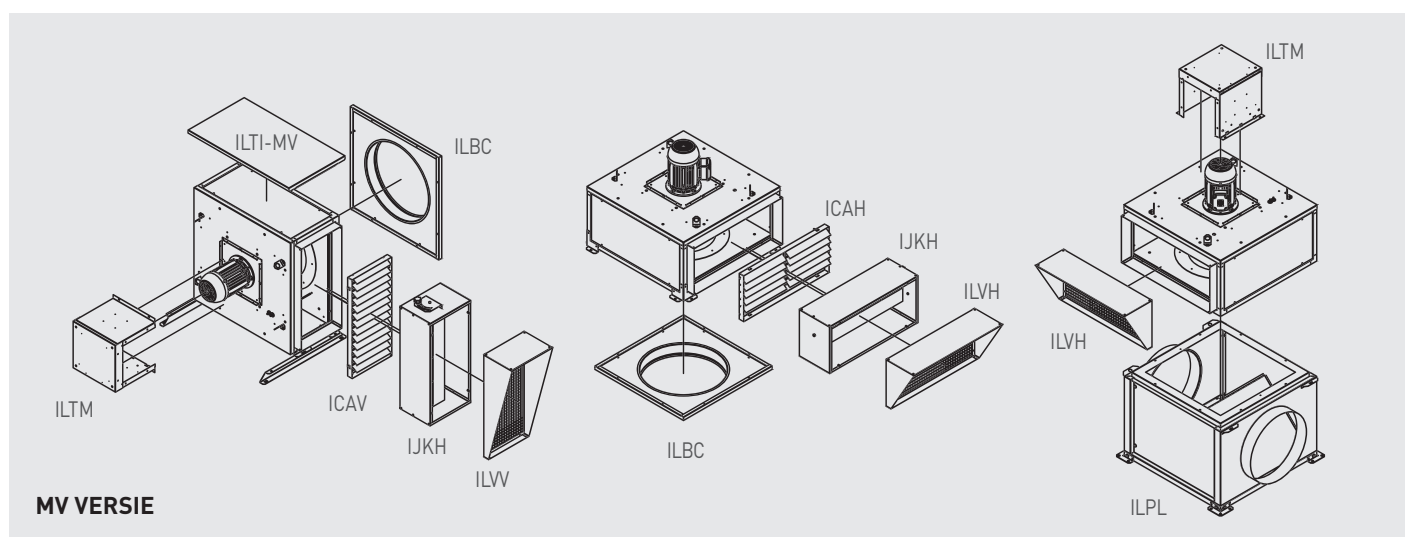

MV VERSIE

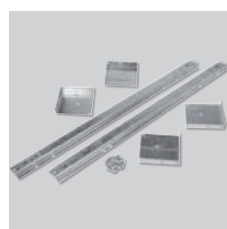

ILSH MV - ILSH CC
Montagehouder met motor
in horizontale positie.

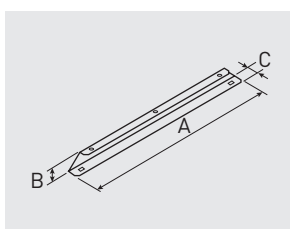

Model	MV			CC		
	A	B	C	A	B	C
355	668	50	35	848	50	35
400	668	50	35	823	50	35
450	668	50	35	1048	50	35
500	762	50	35	1097	50	35
560	762	50	35	1197	50	35
630	855	50	35	1242	50	35
710	977	50	35	1401	50	35
800	962	65	35	1437	65	35

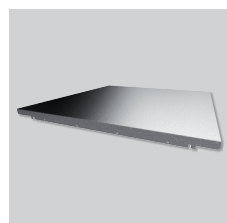

ILTI MV - ILTI CC
Dak, voor unit in
buitenopstelling, met de
motor in horizontale positie.

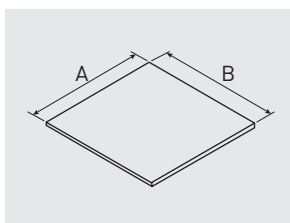

Model	MV		CC	
	A	B	A	B
355	658	391	658	636
400	731	425	731	721
450	812	453	812	790
500	890	485	890	828
560	985	504	985	859
630	1098	550	1098	953
710	1226	610	1226	1112
800	1368	674	1368	1164

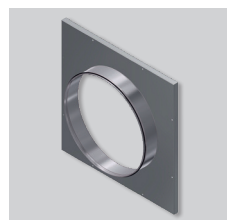

ILBC
Inlaat met ronde
kanaalaansluitingsflens
(MV-versie).

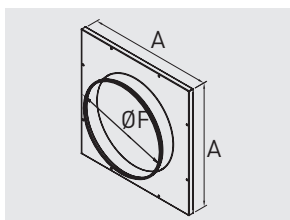

Model	A	F
355	559	400
400	631	450
450	711	500
500	768	560
560	864	630
630	977	710
710	1104	800
800	1248	900

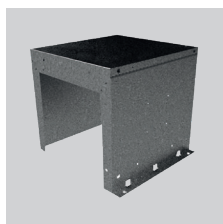

ILTM
Motorkap.

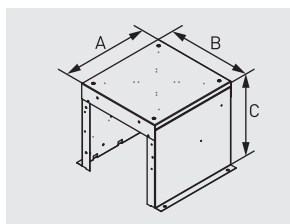

Model	A	B	C
355	340	325	305
400	340	325	305
450	340	325	305
500	415	475	355
560	415	475	355
630	415	475	355
710	510	465	450
800	510	465	450



ILRC
Uitlaat met ronde kanaalaansluitingsflens.

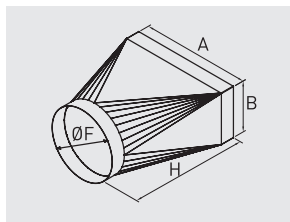

Model	A	B	F	H
355	559	266	400	670
400	631	300	450	670
450	711	329	500	670
500	768	341	560	670
560	864	357	63	670
630	977	406	710	670
710	1104	465	800	670
800	1248	491	900	670



ILAR
Buigzame, rechthoekige kanaalaansluitingsflens.

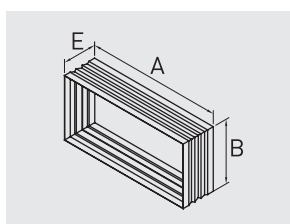

Model	A	B	E
355	559	266	160
400	631	300	160
450	711	329	160
500	768	341	160
560	864	357	160
630	977	406	160
710	1104	465	160
800	1248	491	160



ACOPEL F400 N
Ronde flexibele aansluiting.
Gecertificeerd F400-120.

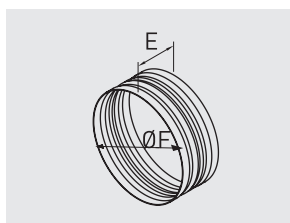

Model	E	F
355	160	400
400	160	450
450	160	500
500	160	560
560	160	63
630	160	710
710	160	800
800	160	900

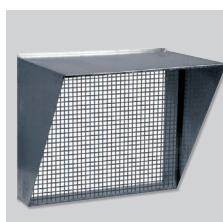

ILVV - ILVH
Afvoerbeveiliging.

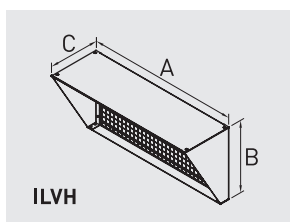

Model	A	B	C
355	559	263	197
400	631	297	216
450	711	326	233
500	768	338	240
560	864	354	250
630	977	403	278
710	1104	462	311
800	1248	488	328

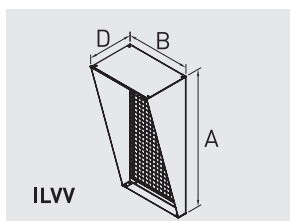

Model	A	B	D
355	559	263	194
400	631	297	213
450	711	326	234
500	768	338	249
560	864	354	275
630	977	403	305
710	1104	462	340
800	1248	488	378



IJKH
Volumeregelaar, F400-120 gecertificeerd.

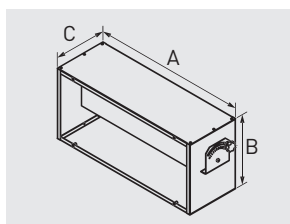

Model	A	B	C
355	559	263	224
400	631	297	247
450	711	326	245
500	768	338	256
560	864	354	267
630	977	403	302
710	1104	462	343
800	1248	488	361



ICAH
Terugslagklep
F400-120 gecertificeerd.

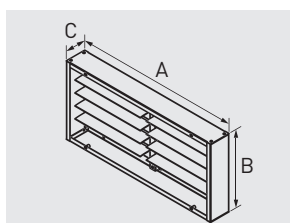

Model	A	B	C
355	559	263	80
400	631	297	80
450	711	326	80
500	768	338	80
560	864	354	80
630	977	403	80
710	1104	462	80
800	1248	488	80



ICAV
Terugslagklep
F400-120 gecertificeerd.

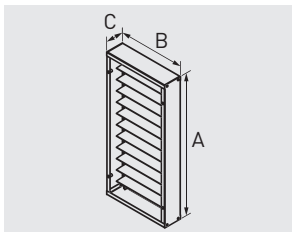

Model	A	B	C
355	559	263	80
400	631	297	80
450	711	326	80
500	768	338	80
560	864	354	80
630	977	403	80
710	1104	462	80
800	1248	488	80

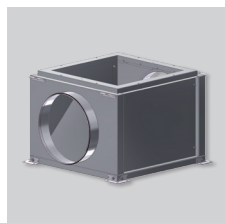

ILPL
Dubbel aanzuigplenum
(MV-versie).

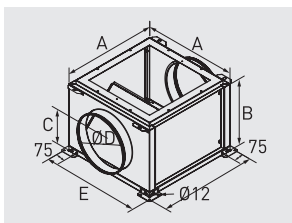

Model	A	B	C	D	E	kg
355	622	448	238	355	662	21
400	694	498	260	400	734	25
450	774	555	289	450	814	30
500	852	675	349	560	892	37
560	948	755	389	630	988	60
630	1060	805	441	630	1100	81
710	1188	885	481	710	1228	99



ISA-ILHT
Trillingen dempers
(Set van 4 rubberen steunen).

ELECTRICAL ACCESSORIES



VFKB IP65
Verstelbare
frequentieregelaars
voor
driefasenmotoren
van 0,37 tot 4 kW
230 V of 400 V.



VFTM IP21
Verstelbare
frequentieregelaar
voor driefasen-
motoren.



SCO2-A
CO₂ en temperatuur-
sensor.
SCO2-AD
CO₂ en temperatuur-
sensor met display.
SCHT-AD
CO₂ sensor,
temperatuur en
relatieve luchtvoch-
tigheid met display.



CPFL-S / CPFL-E
Aanwezigheidsmelder.



TDP-S/TDP-D/TDP-PI
Druk sensor zonder
display.



AAN/UIT
Schakelaar