



Range axiale fans met cilindrisch frame, dat cataforisch behandeld en met polyester verf gelakt is, met een laag geluidsniveau en dynamisch gebalanceerde waaier.

Motoren

Borstelloze EC motor met hoog rendement en laag verbruik, voeding 230V±10% 50/60Hz, IP44, met kogellagers en thermische bescherming. De snelheid is 100% instelbaar middels een potentiometer die is geplaatst in de elektrische box, of via een externe controller, type REB-ECOWATT. Analoge input met een 0-10V extern signaal. Ze werken bij omgevingstemperaturen van -20 °C tot +50 °C.

Extra informatie

Luchtrichting: Vorm (B) configuratie (waaier over motor)



Bestand tegen corrosie
Frame wordt beschermt middels cataforische behandeling en zwarte polyester lak.



Aansluit box IP65

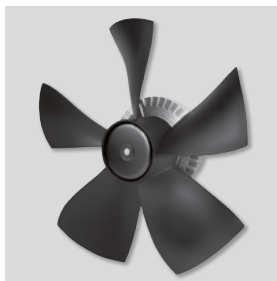

Hoog-rendement "AMAX" waaier
Ontworpen om zeker te zijn van een optimale luchtstroom en zeer laag geluidsniveau. Gemaakt van polyamide verstrekt plastic.

TECHNISCHE GEGEVENS

Controleer vóór het tot stand brengen van een elektrische aansluiting of de spanning en de frequentie van het lichtnet overeenkomen met de technische gegevens op het typeplaatje.

Model	Stuurstroom Voltage (V)	Toerental (r.p.m.)	Maximale opgenomen vermogen (W)	Maximale opgenomen stroom (A)	Maximale capaciteit (m³/h)	Geluiddrukniveau gemeten* (dB(A))	Gewicht (kg)
TXBR-250 ECOWATT	10	2275	131	0,9	2.040	58	4,5
	8	1980	88	0,6	1.790	54	
	6	1570	45	0,3	1.425	48	
	4	1155	19	0,1	1.025	41	
TXBR-315 ECOWATT	10	1675	169	1,1	2.930	57	6
	8	1560	136	0,9	2.730	55	
	6	1255	73	0,5	2.170	51	
	4	960	36	0,3	1.670	42	
TXBR-355 ECOWATT	10	1550	190	1,2	3.605	57	8
	8	1460	159	1	3.425	55	
	6	1235	95	0,6	2.870	52	
	4	1020	55	0,4	2.365	46	
TXBR-400 ECOWATT	10	1350	326	1,4	5.170	59	8,5
	8	1245	249	1,1	4.750	56	
	6	1060	153	0,7	4.090	53	
	4	870	92	0,4	3.325	48	
TXBR-450 ECOWATT	10	1250	350	1,5	6.455	59	9
	8	1200	310	1,4	6.125	58	
	6	1030	201	0,9	5.260	55	
	4	870	123	0,6	4.410	51	

* Geluiddruk is gemeten in vrije veld condities, op een afstand gelijk aan het equivalent van 3 maal de waaiër diameter, met een minimum van 1,5 meter.

AFMETINGEN (mm)

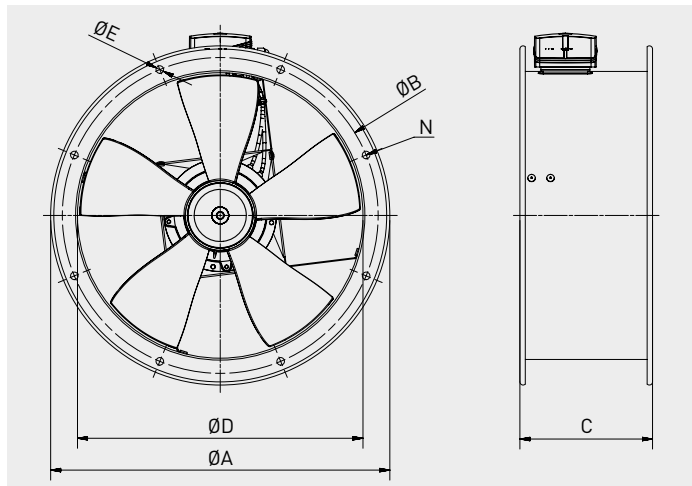

Model	ØA	ØB	C	ØD	ØE	Aantal gaten N
250	327	292	180	256	10	4
315	386	355	180	319	10	8
355	426	395	180	359	10	8
400	487	450	210	403	12	8
450	537	500	210	452	12	8

PRESTATIECURVES

- q_v : Luchtvolume in m^3/h en m^3/s .
- p_{sf} : statische druk in Pa.
- SFP: Specifiek vermogen $W/m^3/s$.
- P: Ogenomen vermogen in W.
- Meet categorie
- Efficiency categorie.
- Ventilator rendement zonder toeren regeling.
- Ventilator getest.
- Luchtstroom data in overeenstemming met ISO 5801.
- Geluiddruk is gemeten in vrije veld condities, op een afstand gelijk aan het equivalent van 3 maal de waaier diameter, met een minimum van 1,5 meter.

- MC** Maatvoering categorie
- EC** Rendements categorie
- VSD** Snelheidsregeling: geleverd bij de ventilator
- SR** Specifieke ratio
- η [%]** Totaal rendement
- N** Rendement
- [kW]** Opgenomen vermogen
- [m^3/h]** Lucht volume
- [Pa]** Statische druk
- [RPM]** Snelheid

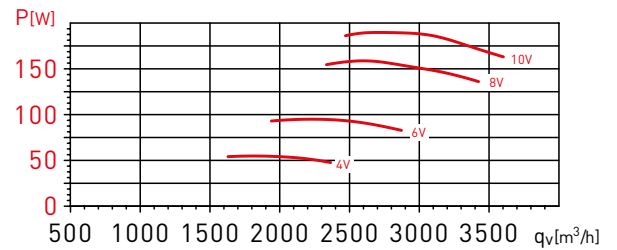
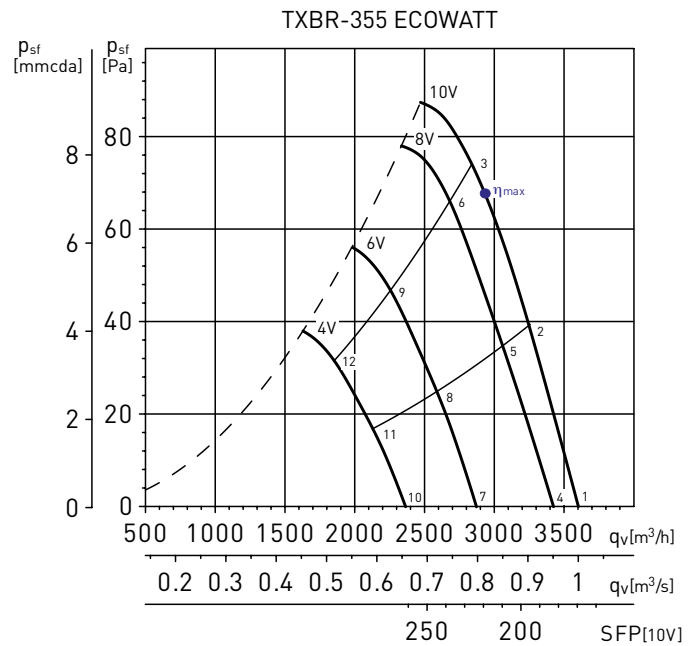

MC	EC	VSD	SR	η [%]	N	[kW]	[m^3/h]	[Pa]	[RPM]
D	Total	Ja	1	52,5	63,4	0,189	2.873	72	1549

PRESTATIECURVES

- q_v = Luchtvolume in m^3/h en m^3/s .
- p_{sf} = Statische druk in Pa.
- SFP: Specifiek ventilatorvermogen in $W/m^3/s$ (blauwe curves).
- Droge lucht bij 20 °C en 760 mmHg.
- Gegevens over prestatievermogen in overeenstemming met ISO 5801 en AMCA 210-99 normen.

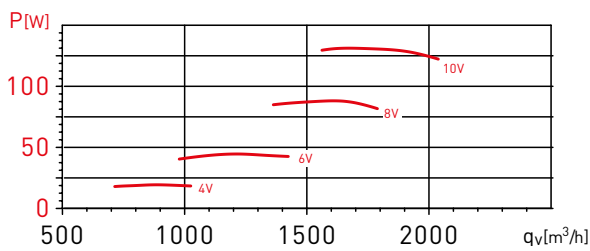
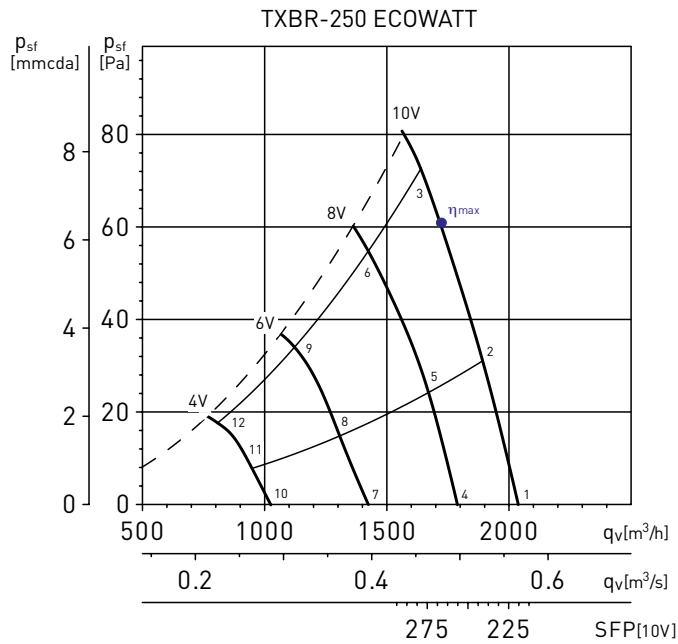

MC	EC	VSD	SR	η [%]	N	[kW]	[m^3/h]	[Pa]	[RPM]
D	Total	Ja	1	48,1	60	0,131	1.617	75	2272

Geluidsvermogensspectra in dB(A)

Werkpunt		63	125	250	500	1.000	2.000	4.000	8.000	LwA
1	Inlaat	36	52	65	65	68	67	61	53	73
	Uitlaat	46	50	66	67	69	66	61	53	74
	Straling	26	46	50	52	56	51	46	38	60
2	Inlaat	36	52	64	65	68	67	62	53	73
	Uitlaat	45	56	69	68	71	68	61	50	75
	Straling	26	46	50	52	56	52	47	38	60
3	Inlaat	46	60	66	66	69	67	60	50	74
	Uitlaat	45	56	68	67	69	66	60	49	74
	Straling	36	55	52	54	57	52	45	35	61
4	Inlaat	34	51	60	60	63	62	56	47	68
	Uitlaat	41	49	62	62	65	62	56	47	69
5	Inlaat	24	45	45	48	52	47	41	32	55
	Uitlaat	34	50	59	60	63	63	57	48	68
6	Inlaat	36	49	62	62	64	62	57	48	69
	Uitlaat	36	49	62	62	64	62	57	48	69
	Straling	25	44	44	48	52	48	41	33	55
7	Inlaat	45	55	62	61	64	62	55	44	69
	Uitlaat	44	53	64	62	65	62	55	43	70
	Straling	36	49	47	49	53	47	39	29	57
8	Inlaat	32	45	54	54	57	56	50	38	62
	Uitlaat	34	43	57	56	59	55	49	38	63
	Straling	23	39	39	43	45	41	33	22	49
9	Inlaat	32	44	54	54	57	57	50	39	62
	Uitlaat	32	43	58	56	59	57	50	39	64
	Straling	23	37	39	43	45	42	34	23	49
10	Inlaat	46	46	55	55	58	56	46	35	62
	Uitlaat	45	43	57	56	59	55	46	34	63
	Straling	37	40	40	44	46	40	30	19	50
11	Inlaat	30	38	47	47	49	47	38	26	54
	Uitlaat	29	35	48	47	50	45	37	25	54
12	Inlaat	25	35	37	40	39	34	24	15	45
	Uitlaat	29	37	47	47	51	50	41	28	55
	Straling	24	35	37	40	41	37	26	17	45
13	Inlaat	35	37	47	48	50	46	34	25	54
	Uitlaat	34	35	48	48	51	44	33	24	54
	Straling	30	35	37	40	40	33	20	14	45

PRESTATIECURVES

- q_v = Luchtvolume in m^3/h en m^3/s .
- p_{sf} = Statische druk in Pa.
- SFP: Specifiek ventilatorvermogen in $W/m^3/s$ (blauwe curves).
- Droge lucht bij $20\text{ }^\circ\text{C}$ en 760 mmHg .
- Gegevens over prestatievermogen in overeenstemming met ISO 5801 en AMCA 210-99 normen.

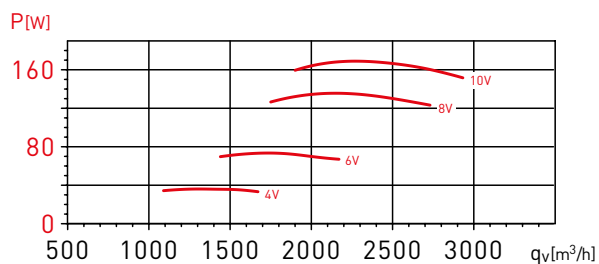
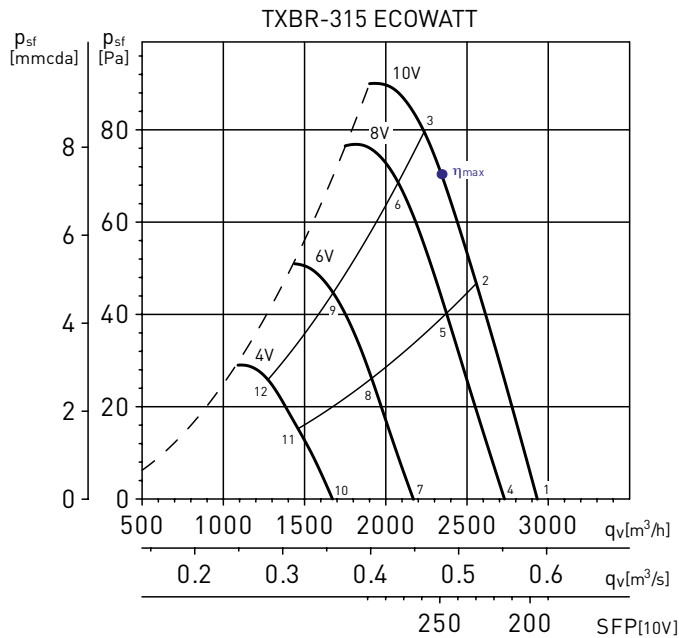

MC	EC	VSD	SR	η [%]	N	[kW]	[m^3/h]	[Pa]	[RPM]
D	Total	Ja	1	50,4	61,6	0,169	2.299	74	1675

Geluidsvermogensspectra in dB(A)

Werkpunt		63	125	250	500	1.000	2.000	4.000	8.000	LwA
1	Inlaat	38	53	63	65	68	68	63	52	73
	Uitlaat	51	54	66	66	68	69	62	53	74
	Straling	25	44	50	51	49	51	43	29	56
2	Inlaat	38	51	62	62	67	66	61	51	71
	Uitlaat	49	52	66	66	67	67	61	52	73
	Straling	25	42	49	49	47	48	41	28	55
3	Inlaat	37	49	61	62	67	66	60	52	71
	Uitlaat	42	53	64	64	66	66	60	52	72
	Straling	24	41	48	49	47	48	41	29	54
4	Inlaat	37	51	61	62	66	66	60	49	71
	Uitlaat	49	51	64	63	65	66	59	49	71
	Straling	25	42	49	48	46	48	40	25	54
5	Inlaat	37	49	61	60	65	64	59	48	70
	Uitlaat	44	48	63	63	63	63	57	48	69
	Straling	25	41	48	46	45	46	39	25	53
6	Inlaat	36	48	60	60	64	63	57	48	68
	Uitlaat	41	49	63	62	63	63	56	48	69
	Straling	24	39	47	46	44	44	37	24	52
7	Inlaat	35	46	59	55	61	60	53	40	66
	Uitlaat	40	48	59	57	60	60	52	40	65
	Straling	23	38	47	41	41	41	33	17	50
8	Inlaat	35	46	58	55	61	60	53	41	65
	Uitlaat	39	47	59	56	59	59	51	39	65
	Straling	24	38	46	41	40	41	33	17	49
9	Inlaat	33	43	57	54	59	57	51	40	63
	Uitlaat	36	47	59	55	58	57	50	39	64
	Straling	21	35	45	39	38	38	31	17	47
10	Inlaat	32	40	49	47	54	53	42	29	58
	Uitlaat	33	34	51	49	52	51	41	28	57
	Straling	26	31	37	32	33	33	22	11	41
11	Inlaat	30	40	49	47	53	51	42	28	57
	Uitlaat	33	34	51	49	52	51	40	28	57
	Straling	24	31	36	32	32	32	22	10	40
12	Inlaat	28	38	47	46	52	49	41	29	55
	Straling	32	33	51	48	51	49	39	28	56
	Straling	22	30	35	31	31	29	21	11	39

PRESTATIECURVES

- q_v = Luchtvolume in m^3/h en m^3/s .
- p_{sf} = Statische druk in Pa.
- SFP: Specifiek ventilatorvermogen in $W/m^3/s$ (blauwe curves).
- Droge lucht bij 20 °C en 760 mmHg.
- Gegevens over prestatievermogen in overeenstemming met ISO 5801 en AMCA 210-99 normen.

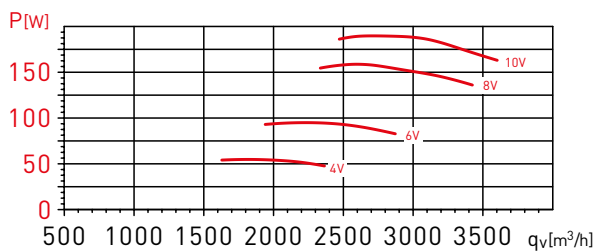
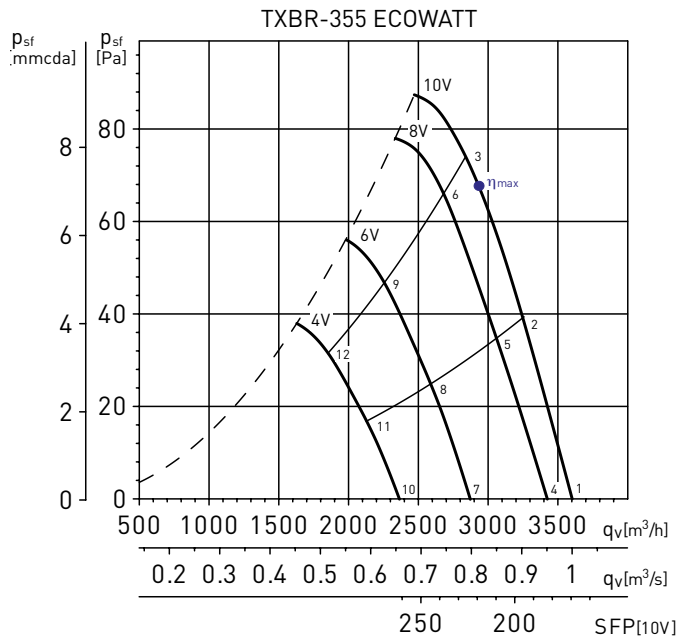

MC	EC	VSD	SR	η [%]	N	[kW]	[m^3/h]	[Pa]	[RPM]
D	Total	Ja	1	52,5	63,4	0,189	2.873	72	1549

Geluidsvermogensspectra in dB(A)

Werkpunt		63	125	250	500	1.000	2.000	4.000	8.000	LwA
1	Inlaat	38	52	62	65	68	66	61	50	72
	Uitlaat	53	56	66	66	67	66	61	51	73
	Straling	24	38	44	50	51	47	41	28	55
2	Inlaat	38	52	62	64	67	65	59	49	71
	Uitlaat	49	54	65	65	66	65	59	50	72
	Straling	25	38	44	50	50	46	40	27	54
3	Inlaat	39	57	63	66	69	66	61	52	73
	Uitlaat	49	55	71	68	70	67	60	49	75
	Straling	26	43	45	51	52	47	41	30	56
4	Inlaat	37	51	61	63	66	64	58	47	70
	Uitlaat	51	53	65	64	65	65	58	48	71
	Straling	24	37	44	49	49	45	38	25	53
5	Inlaat	38	51	60	63	65	63	57	46	69
	Uitlaat	46	51	65	64	64	63	57	47	70
	Straling	25	37	43	49	48	43	36	24	53
6	Inlaat	50	58	66	65	68	64	56	46	72
	Uitlaat	49	54	68	66	67	65	57	46	73
	Straling	38	44	48	51	51	44	36	24	56
7	Inlaat	36	48	60	58	62	60	53	41	66
	Uitlaat	45	48	63	59	61	60	53	41	67
	Straling	25	35	44	45	45	40	33	19	50
8	Inlaat	35	48	61	58	61	59	52	41	66
	Uitlaat	40	47	63	58	60	58	51	41	66
	Straling	24	35	45	45	45	39	32	19	50
9	Inlaat	33	47	60	57	61	58	52	42	65
	Uitlaat	44	49	64	61	63	59	51	40	68
	Straling	22	34	44	44	44	38	32	21	49
10	Inlaat	36	45	52	53	56	54	45	34	60
	Uitlaat	40	40	53	53	56	53	45	33	60
	Straling	24	33	39	40	40	35	25	12	45
11	Inlaat	36	45	52	52	56	53	45	34	60
	Uitlaat	39	39	53	52	55	52	44	32	59
	Straling	24	33	38	40	40	34	24	13	45
12	Inlaat	34	49	55	55	58	55	48	37	62
	Straling	42	42	57	55	57	52	43	32	62
	Straling	22	38	42	42	42	35	27	16	48

PRESTATIECURVES

- q_v = Luchtvolume in m^3/h en m^3/s .
- p_{sf} = Statische druk in Pa.
- SFP: Specifiek ventilatorvermogen in $W/m^3/s$ (blauwe curves).
- Droge lucht bij 20 °C en 760 mmHg.
- Gegevens over prestatievermogen in overeenstemming met ISO 5801 en AMCA 210-99 normen.

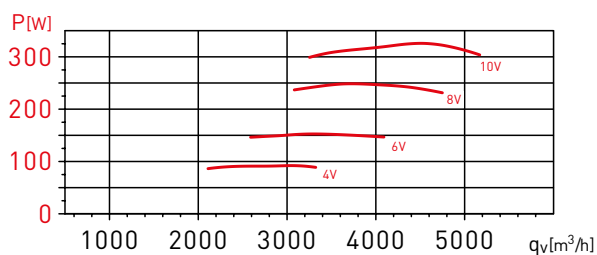
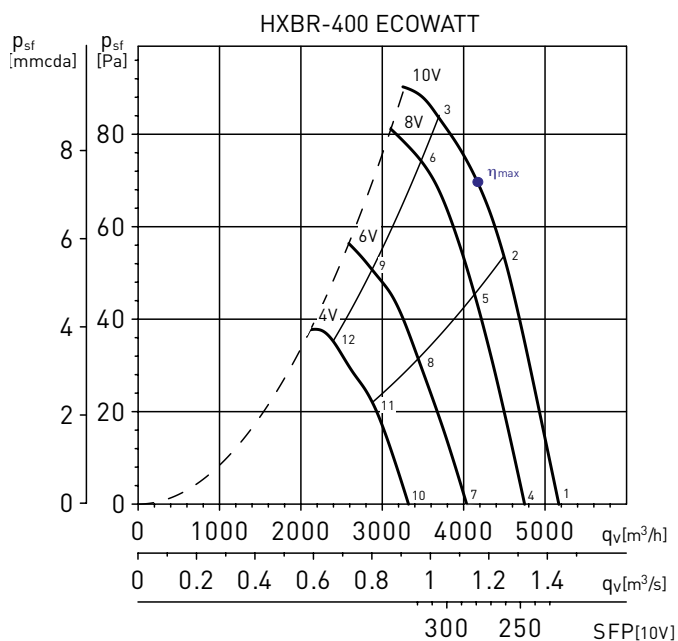

MC	EC	VSD	SR	η [%]	N	[kW]	[m^3/h]	[Pa]	[RPM]
D	Total	Ja	1	48,7	58,1	0,323	4.286	65	1350

Geluidsvermogensspectra in dB(A)

Werkpunt		63	125	250	500	1.000	2.000	4.000	8.000	LwA
1	Inlaat	38	53	63	65	68	67	61	50	73
	Uitlaat	53	56	66	66	68	67	61	51	73
	Straling	25	39	45	51	51	48	41	28	55
2	Inlaat	39	53	62	65	67	66	60	50	72
	Uitlaat	49	55	66	65	67	65	60	50	72
	Straling	26	39	44	50	50	46	40	28	55
3	Inlaat	40	57	64	66	69	67	62	52	73
	Uitlaat	50	56	71	69	70	67	60	50	76
	Straling	27	44	46	51	52	47	42	31	56
4	Inlaat	38	52	62	64	66	65	58	47	71
	Uitlaat	51	53	66	65	66	65	59	48	72
	Straling	25	38	44	50	49	45	38	25	54
5	Inlaat	39	52	61	63	65	63	57	47	70
	Uitlaat	47	51	65	64	65	63	57	48	71
	Straling	26	38	43	49	48	44	37	25	53
6	Inlaat	51	58	66	66	68	64	57	47	73
	Uitlaat	49	54	69	66	68	65	57	47	73
	Straling	38	45	49	51	51	45	37	25	56
7	Inlaat	36	48	60	59	62	60	53	41	67
	Uitlaat	45	49	64	59	62	60	53	42	68
	Straling	25	36	44	46	46	41	33	20	51
8	Inlaat	36	48	61	58	62	60	52	41	67
	Uitlaat	40	47	63	58	61	59	52	41	67
	Straling	25	36	46	45	45	40	32	19	51
9	Inlaat	34	47	60	57	61	58	52	43	66
	Uitlaat	44	49	65	61	63	60	51	40	69
	Straling	23	35	44	44	44	39	32	21	50
10	Inlaat	36	45	53	53	57	54	46	34	61
	Uitlaat	41	40	54	53	56	54	45	33	61
	Straling	24	34	39	41	41	35	25	13	46
11	Inlaat	37	45	52	53	57	54	45	34	61
	Uitlaat	40	39	53	53	55	52	44	33	60
	Straling	25	34	39	41	40	34	25	13	45
12	Inlaat	35	50	56	55	59	55	48	38	63
	Straling	42	43	57	55	57	53	43	32	62
	Straling	22	38	42	43	43	36	28	16	48

PRESTATIECURVES

- q_v = Luchtvolume in m^3/h en m^3/s .
- p_{sf} = Statische druk in Pa.
- SFP: Specifiek ventilatorvermogen in $W/m^3/s$ (blauwe curves).
- Droge lucht bij 20 °C en 760 mmHg.
- Gegevens over prestatievermogen in overeenstemming met ISO 5801 en AMCA 210-99 normen.

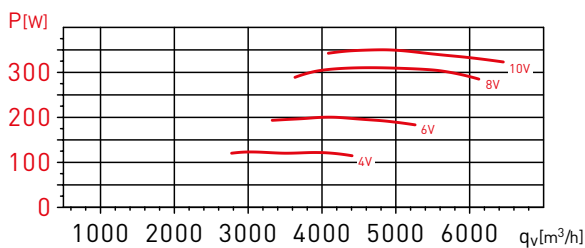
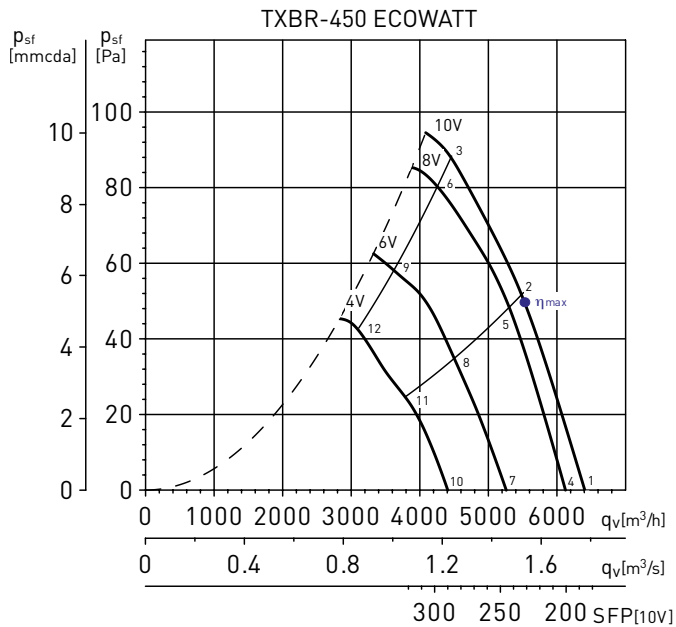

MC	EC	VSD	SR	η [%]	N	[kW]	[m^3/h]	[Pa]	[RPM]
D	Total	Ja	1	55	64,3	0,340	5.517	50	1247

Geluidsvermogensspectra in dB(A)

Werkpunt		63	125	250	500	1.000	2.000	4.000	8.000	LwA
1	Inlaat	38	53	63	65	68	67	61	50	73
	Uitlaat	53	56	66	66	68	67	61	51	73
	Straling	25	39	45	51	51	48	41	28	55
2	Inlaat	39	53	62	65	67	66	60	50	72
	Uitlaat	49	55	66	65	67	65	60	50	72
	Straling	26	39	44	50	50	46	40	28	55
3	Inlaat	40	57	64	66	69	67	62	52	73
	Uitlaat	50	56	71	69	70	67	60	50	76
	Straling	27	44	46	51	52	47	42	31	56
4	Inlaat	38	52	62	64	66	65	58	47	71
	Uitlaat	51	53	66	65	66	65	59	48	72
	Straling	25	38	44	50	49	45	38	25	54
5	Inlaat	39	52	61	63	65	63	57	47	70
	Uitlaat	47	51	65	64	65	63	57	48	71
	Straling	26	38	43	49	48	44	37	25	53
6	Inlaat	51	58	66	66	68	64	57	47	73
	Uitlaat	49	54	69	66	68	65	57	47	73
	Straling	38	45	49	51	51	45	37	25	56
7	Inlaat	36	48	60	59	62	60	53	41	67
	Uitlaat	45	49	64	59	62	60	53	42	68
	Straling	25	36	44	46	46	41	33	20	51
8	Inlaat	36	48	61	58	62	60	52	41	67
	Uitlaat	40	47	63	58	61	59	52	41	67
	Straling	25	36	46	45	45	40	32	19	51
9	Inlaat	34	47	60	57	61	58	52	43	66
	Uitlaat	44	49	65	61	63	60	51	40	69
	Straling	23	35	44	44	44	39	32	21	50
10	Inlaat	36	45	53	53	57	54	46	34	61
	Uitlaat	41	40	54	53	56	54	45	33	61
	Straling	24	34	39	41	41	35	25	13	46
11	Inlaat	37	45	52	53	57	54	45	34	61
	Uitlaat	40	39	53	53	55	52	44	33	60
	Straling	25	34	39	41	40	34	25	13	45
12	Inlaat	35	50	56	55	59	55	48	38	63
	Straling	42	43	57	55	57	53	43	32	62
	Straling	22	38	42	43	43	36	28	16	48

MONTAGE ACCESSOIRES

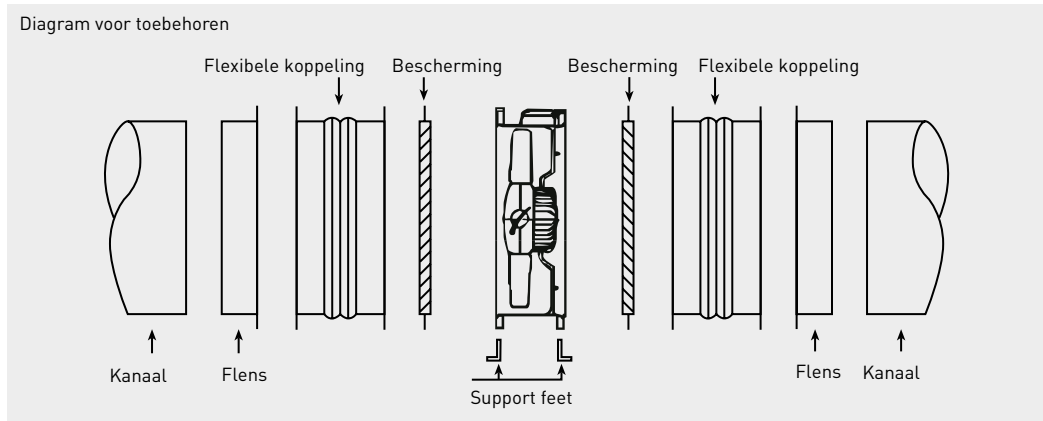

Model	Bescherming Inlaat/Uitlaat	Flenzen	Bevestigingsvoeten	Flexibele koppeling
250	DEF-250 T	ARO BRIDA COMPACT-250	PIE-250	ACOP.BRIDA-250
315	DEF-315 T	ARO BRIDA COMPACT-315	PIE-315	ACOP.BRIDA-315
355	DEF-355 T	ARO BRIDA COMPACT-355	PIE-355	ACOP.BRIDA-355
400	DEF-400 T	ARO BRIDA COMPACT-400	PIE-400	ACOP.BRIDA-400
450	DEF-450 T	ARO BRIDA COMPACT-450	PIE-450	ACOP.BRIDA-450

ELEKTRISCHE ACCESSOIRES



REB-ECOWATT
Enkelfasige elektronische toerentalregelaars.



CONTROL ECOWATT BASIC
Snelheid instelling en enkel fase ON/OFF



CONTROL ECOWATT
Regeleenheid met functies voor COP/VAV/MIN-MAX.



CPFL
Aanwezigheidsmelder.



SC02-A
CO₂ en temperatuursensor.

SC02-AD
CO₂ en temperatuursensor met display.

SCHT-AD
CO₂-sensor, temperatuur en relatieve luchtvochtigheid met display.

SC02-AR
CO₂-sensor, temperatuur. Relaisuitgang



TDP-S
Druk sensor zonder display.

TDP-D
Druk sensor met een display.

TDP-PI
Druk sensor met een display.